

## 504WC1E-W2-3P

5mm, White LED

Cylindrical With Flange Type

## Technical Data Sheet

---

### Features:

- Low power consumption.
- General purpose leads.
- Versatile mounting on p.c. board or panel.
- I.C. compatible/low current requirement.
- Bulk, Available on tape and reel.
- High efficiency.
- Compliance with EU REACH.
- The product itself will remain within RoHS compliant Version.

### Descriptions:

- The series is specially designed for applications requiring higher brightness.
- The phosphor filled in the reflector converts the blue emission of InGaN chip to ideal white.
- Through hole white LEDs are offered in a variety of packages such as 3mm, 4mm, 5mm, 8mm,10mm, rectangular and cylinder which are suitable for all applications requiring status indication. Several intensity and viewing angle choices are available in each package for design flexibility.

### Applications:

- Message panels.
- Optical Indicators.
- Backlighting.
- Marker Lights.
- Home appliance.

### Device Selection Guide

| Part No.      | Emitting Color | Lens Color  |
|---------------|----------------|-------------|
| 504WC1E-W2-3P | Cool White     | Water Clear |

# 504WC1E-W2-3P

5mm, White LED

Cylindrical With Flange Type

## Technical Data Sheet

### Package Dimension:

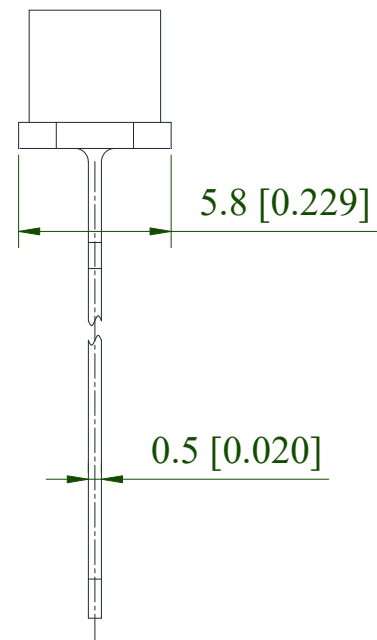
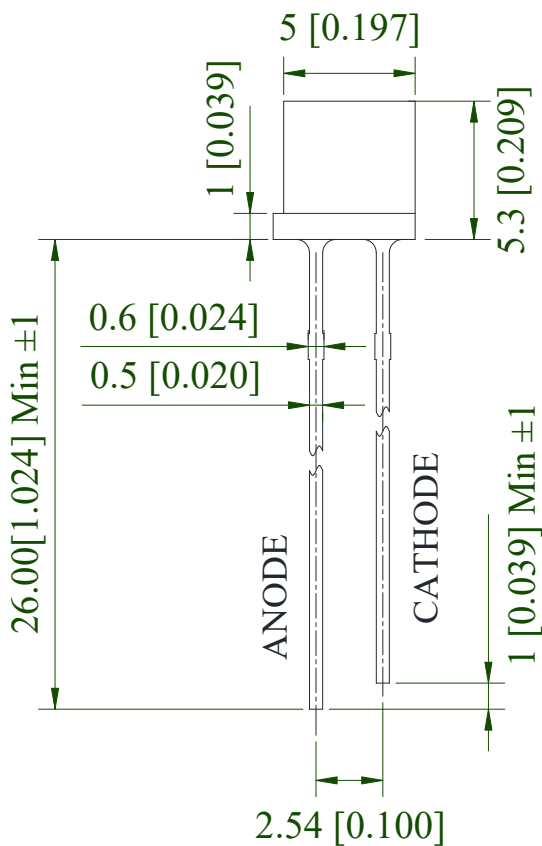
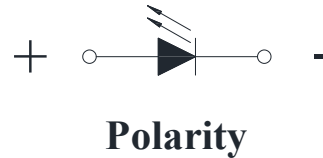
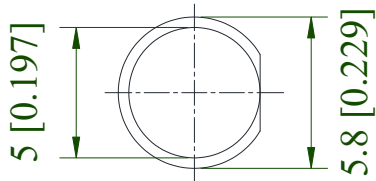

### Notes:

1. All dimensions are in millimeters (inches).
2. Tolerance is  $\pm 0.25$  mm (.010") unless otherwise noted.
3. Protruded resin under flange is 1.00mm (.039") max.

# 504WC1E-W2-3P

5mm, White LED

Cylindrical With Flange Type



## Technical Data Sheet

### Absolute Maximum Ratings at Ta=25°C

| Parameters                          | Symbol    | Max.                | Unit |
|-------------------------------------|-----------|---------------------|------|
| Power Dissipation                   | $P_d$     | 90                  | mW   |
| Peak Forward Current <sup>(a)</sup> | $I_{FP}$  | 100                 | mA   |
| DC Forward Current <sup>(b)</sup>   | $I_F$     | 25                  | mA   |
| Reverse Voltage <sup>(c)</sup>      | $V_R$     | 5                   | V    |
| Operating Temperature Range         | $T_{opr}$ | -40°C to +80°C      |      |
| Storage Temperature Range           | $T_{stg}$ | -40°C to +85°C      |      |
| Soldering Temperature               | $T_{sld}$ | 260°C for 5 Seconds |      |

Notes:

- Derate linearly as shown in derating curve.
- Duty Factor = 10%, Frequency = 1 kHz.
- Reverse voltage ( $V_R$ ) condition is applied for IR test only. The device is not designed for reverse operation.

### Electrical Optical Characteristics at Ta=25°C

| Parameters                              | Symbol          | Min. | Typ.  | Max. | Unit    | Test Condition |
|---|-----------------|------|-------|------|---------|----------------|
| Luminous Intensity <sup>(a)</sup>       | $I_v$           | 1000 | 1700  | ---  | mcd     | IF=20mA        |
| Viewing Angle <sup>(b)</sup>            | $2\theta_{1/2}$ | ---  | 100   | ---  | deg.    | IF=20mA        |
| Chromaticity Coordinates <sup>(c)</sup> | x               | ---  | 0.28  | ---  |         | IF=20mA        |
|   | y               | ---  | 0.28  | ---  |         | IF=20mA        |
| Color Temperature                       | CCT             | ---  | 11000 | ---  | K       | IF=20mA        |
| Color Rendering Index                   | CRI             | ---  | 80    | ---  | Ra      | IF=20mA        |
| Forward Voltage                         | VF              | 2.60 | 3.10  | 3.60 | V       | IF=20mA        |
| Reverse Current <sup>(d)</sup>          | IR              | ---  | ---   | 10   | $\mu$ A | VR=5V          |

Notes:

- Luminous intensity is measured with a light sensor and filter combination that approximates the CIE eye-response curve. The  $I_v$  guarantee must be included with  $\pm 15\%$  testing tolerance.
- $2\theta_{1/2}$  is the  $\theta$ -axis angle where the luminous intensity is 1/2 the peak intensity.
- The chromaticity coordinates (x, y) is derived from the 1931 CIE chromaticity diagram.
- Reverse current (IR) condition is applied for VR test only. The device is not designed for reverse operation.

# 504WC1E-W2-3P

5mm, White LED

Cylindrical With Flange Type



## Technical Data Sheet

### Typical Electrical / Optical Characteristics Curves (25°C Ambient Temperature Unless Otherwise Noted)

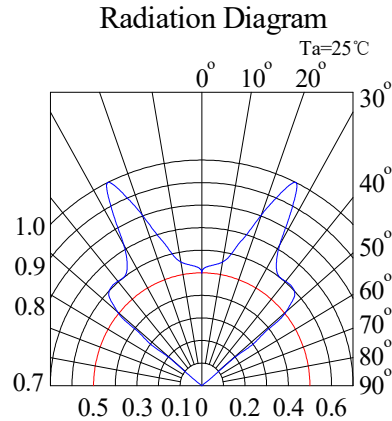
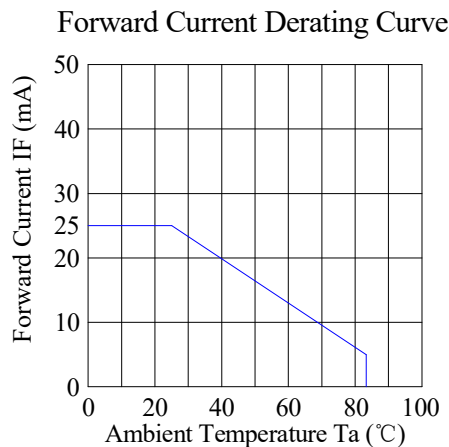
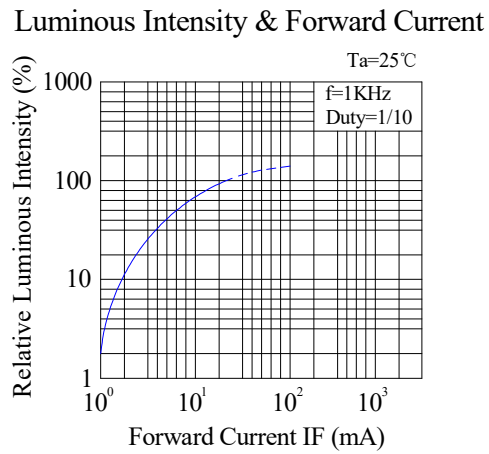
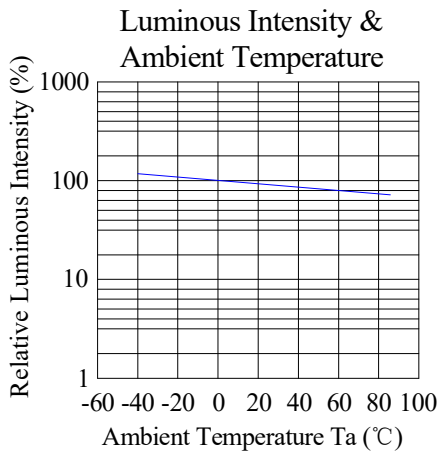
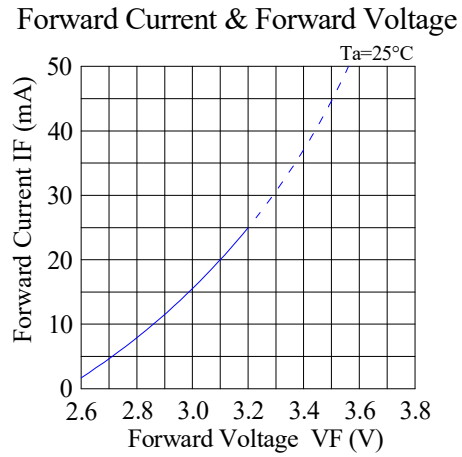
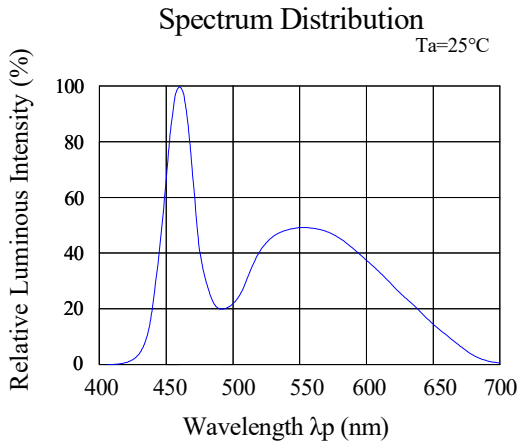

# 504WC1E-W2-3P

5mm, White LED

Cylindrical With Flange Type



## Technical Data Sheet

### CIE Chromaticity Diagram:

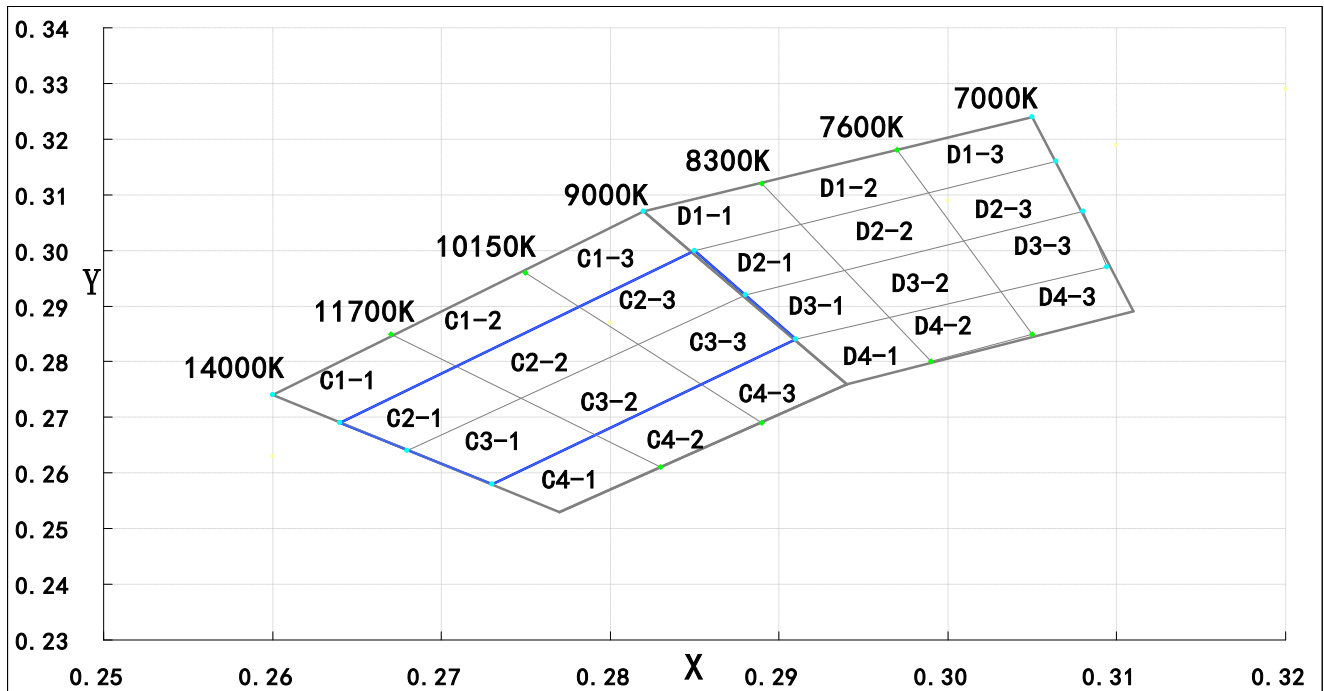

### Chromaticity Coordinates Specifications for Bin Rank:

| Bin Code | Left x | Left y | Top x | Top y | Right x | Right y | Bottom x | Bottom y |
|----------|--------|--------|-------|-------|---------|---------|----------|----------|
| C2-1     | 0.268  | 0.264  | 0.275 | 0.273 | 0.271   | 0.279   | 0.264    | 0.269    |
| C3-1     | 0.273  | 0.258  | 0.279 | 0.267 | 0.275   | 0.273   | 0.268    | 0.264    |
| C2-2     | 0.275  | 0.273  | 0.282 | 0.283 | 0.285   | 0.290   | 0.271    | 0.279    |
| C3-2     | 0.279  | 0.267  | 0.285 | 0.276 | 0.282   | 0.283   | 0.275    | 0.273    |
| C2-3     | 0.282  | 0.283  | 0.288 | 0.292 | 0.285   | 0.300   | 0.278    | 0.290    |
| C3-3     | 0.285  | 0.276  | 0.291 | 0.284 | 0.288   | 0.292   | 0.282    | 0.283    |

Note: Color Coordinates Measurement allowance is  $\pm 0.012$ .

# 504WC1E-W2-3P

5mm, White LED

Cylindrical With Flange Type

## Technical Data Sheet

---

### Bin Table Specification:

#### Luminous Intensity $I_v$ (mcd) $I_F@20mA$

| Bin Code | Min  | Max. |
|----------|------|------|
| 18       | 1000 | 1300 |
| 19       | 1300 | 1700 |
| 20       | 1700 | 2200 |
| 21       | 2200 | 2900 |

Note: Tolerance of each bin limit is  $\pm 15\%$ .

#### Forward Voltage $V_F$ (V) $I_F@20mA$

| Bin Code | Min | Max. |
|----------|-----|------|
| B        | 2.6 | 2.8  |
| C        | 2.8 | 3.0  |
| D        | 3.0 | 3.2  |
| E        | 3.2 | 3.4  |
| F        | 3.4 | 3.6  |

Note: Forward Voltage Measurement allowance is  $\pm 0.2V$ .

#### Chromaticity Coordinates, CC (x, y), $I_F@20mA$

| Bin Code | Chromaticity Coordinates, $I_F@20mA$ |       |       |       |       |
|----------|--------------------------------------|-------|-------|-------|-------|
| C2-1     | x                                    | 0.268 | 0.275 | 0.271 | 0.264 |
|          | y                                    | 0.264 | 0.273 | 0.279 | 0.269 |
| C3-1     | x                                    | 0.273 | 0.279 | 0.275 | 0.268 |
|          | y                                    | 0.258 | 0.267 | 0.273 | 0.264 |
| C2-2     | x                                    | 0.275 | 0.282 | 0.278 | 0.271 |
|          | y                                    | 0.273 | 0.283 | 0.290 | 0.279 |
| C3-2     | x                                    | 0.279 | 0.285 | 0.282 | 0.275 |
|          | y                                    | 0.267 | 0.276 | 0.283 | 0.273 |
| C2-3     | x                                    | 0.282 | 0.288 | 0.285 | 0.278 |
|          | y                                    | 0.283 | 0.292 | 0.300 | 0.290 |
| C3-3     | x                                    | 0.285 | 0.291 | 0.288 | 0.282 |
|          | y                                    | 0.276 | 0.284 | 0.292 | 0.283 |

Note: Color Coordinates Measurement allowance is  $\pm 0.012$ .

# 504WC1E-W2-3P

5mm, White LED

Cylindrical With Flange Type

## Technical Data Sheet

### Packing & Label Specifications:

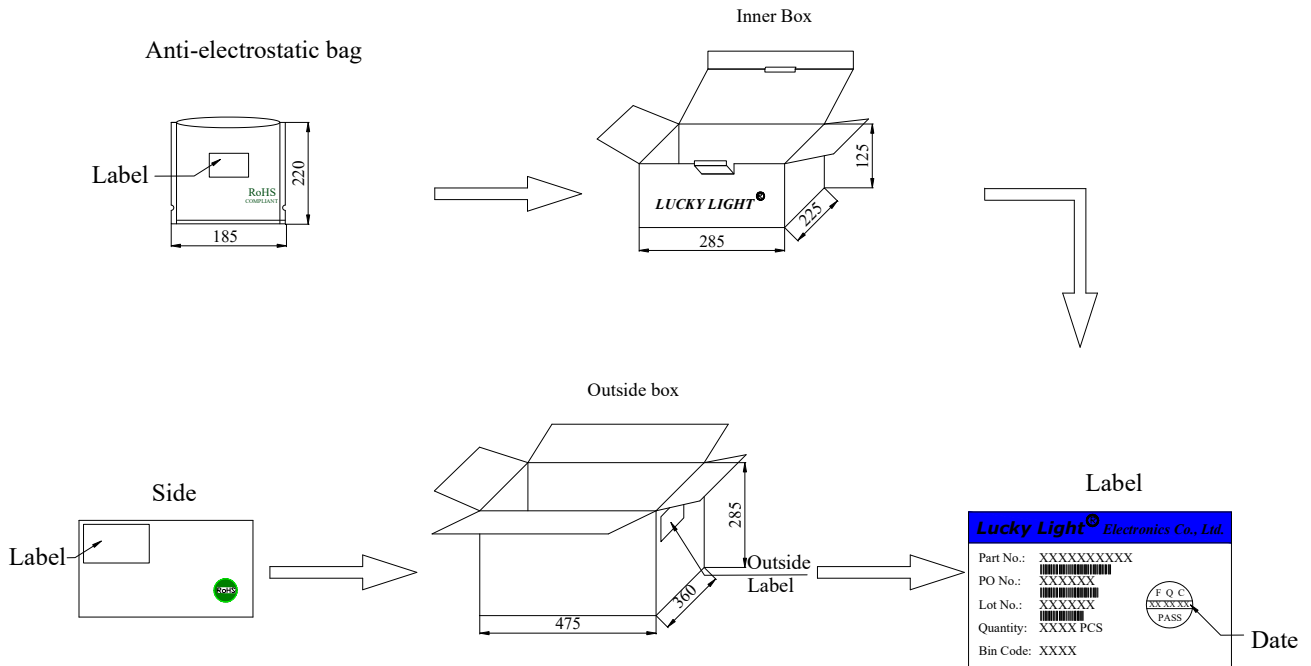

### Packing Quantity:

- a. 500 PCS/bag.
- b. 8000 PCS/Inner Box.
- c. 6 Inner Boxes/Outside Box.

## Technical Data Sheet

### CAUTIONS

**1. Over-current-proof**

Customer must apply resistors for protection, otherwise slight voltage shift will cause big current change (Burn out will happen).

**2. Storage**

2.1 The LEDs should be stored at 30°C or less and 70%RH or less after being shipped from LuckyLight and the storage life limits are 3 months. If the LEDs are stored for 3 months or more, they can be stored for a year in a sealed container with a nitrogen atmosphere and moisture absorbent material.

2.2 Please avoid rapid transitions in ambient temperature, especially, in high humidity environments where condensation can occur.

**3. Cleaning**

Use alcohol-based cleaning solvents such as isopropyl alcohol to clean the LEDs if necessary.

**4. Lead Forming & Assembly**

During lead forming, the leads should be bent at a point at least 1.6mm from the base of LED lens. Do not use the base of the lead frame as a fulcrum during forming. Lead forming must be done before soldering, at normal temperature. During assembly on PCB, use minimum clinch force possible to avoid excessive mechanical stress.

**5. Soldering**

When soldering, for Lamp without stopper type and must be leave a minimum of 3mm clearance from the base of the lens to the soldering point. Do not apply any external stress to the lead frame during soldering while the LED is at high temperature.

**Recommended soldering conditions:**

| Soldering Iron |                                | Wave Soldering |              |
|----------------|--------------------------------|----------------|--------------|
| Temperature    | 300°C Max.                     | Pre-heat       | 100°C Max.   |
| Soldering Time | 3 sec. Max.<br>(one time only) | Pre-heat Time  | 60 sec. Max. |
|                |                                | Solder Wave    | 260°C Max.   |
|                |                                | Soldering Time | 5 sec. Max.  |

Note: Excessive soldering temperature and / or time might result in deformation of the LED lens or catastrophic failure of the LED.

**6. Drive Method**

An LED is a current-operated device. In order to ensure intensity uniformity on multiple LEDs connected in parallel in an application, it is recommended that a current limiting resistor be incorporated in the drive circuit, in series with each LED as shown in Circuit A below.

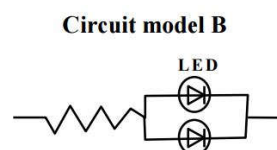
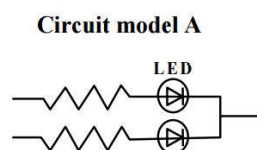



## Technical Data Sheet

---

(A) Recommended circuit

(B) The brightness of each LED might appear different due to the differences in the I-V characteristics of those LEDs.

### 7. Repairing

Repair should not be done after the LEDs have been soldered. When repairing is unavoidable, a double-head soldering iron should be used. It should be confirmed beforehand whether the characteristics of the LEDs will or will not be damaged by repairing.

### 8. ESD (Electrostatic Discharge)

Static Electricity or power surge will damage the LED. Suggestions to prevent ESD damage:

8.1. Use a conductive wrist band or anti- electrostatic glove when handling these LEDs.

8.2. All devices, equipment, and machinery must be properly grounded.

8.3. Work tables, storage racks, etc. should be properly grounded.

8.4. Use ion blower to neutralize the static charge which might have built up on surface of the LEDs plastic lens as a result of friction between LEDs during storage and handing.

ESD-damaged LEDs will exhibit abnormal characteristics such as high reverse leakage current, low forward voltage, or “no light up” at low currents.

To verify for ESD damage, check for “light up” and VF of the suspect LEDs at low currents.

The VF of “good” LEDs should be  $>2.0V@0.1mA$  for InGaN product and  $>1.4V@0.1mA$  for AlInGaP product.

### 9. Others

9.1 The information included in this document reflects representative usage scenarios and is intended for technical reference only.

9.2 The part number, type, and specifications mentioned in this document are subject to future change and improvement without notice. Before production usage customer should refer to the latest datasheet for the updated specifications.

9.3 When using the products referenced in this document, please make sure the product is being operated within the environmental and electrical limits specified in the datasheet. If customer usage exceeds the specified limits, LuckyLight will not be responsible for any subsequent issues.

9.4 The LEDs described here are intended to be used for ordinary electronic equipment (such as office equipment, communication equipment and household applications). Consult LuckyLight's Sales in advance for information on applications in which exceptional reliability is required, particularly when the failure or malfunction of the LEDs may directly jeopardize life or health, such as in aviation, transportation, traffic control equipment, medical and life support systems and safety devices.