

A21GC-2B-TR6

2.15x2.4mm, Yellow Green LED

Subminiature Axial Flat Top View Chip LED Indicator

LuckyLight

Technical Data Sheet

Features:

- Small double-end package.
- EIA Std. package.
- Mono-color type.
- High reliability.
- Low forward voltage.
- Compatible with automatic placement equipment.
- The product itself will remain within RoHS compliant version.

Descriptions:

- The A21 SMD taping is much smaller than leaded components. Thus enable smaller board size. Higher packing density. Reduced storage space and finally smaller equipment to be obtained.
- Besides, light weight makes them ideal for miniature applications.
- Furthermore by automation assembly machines the accuracy is anticipated.

Applications:

- Small indicator for indoor applications.
- Flat backlight for LCD, switches and symbols.
- Indicator and backlight in office equipment.
- Indicator and backlight for battery driven equipment.
- Indicator and backlight for audio and video equipment.

A21GC-2B-TR6

2.15x2.4mm, Yellow Green LED

Subminiature Axial Flat Top View Chip LED Indicator



Technical Data Sheet

| Part No. | Emitting Color | Lens Color |
|--------------|----------------|-------------|
| A21GC-2B-TR6 | Yellow Green | Water Clear |

Package Dimension:

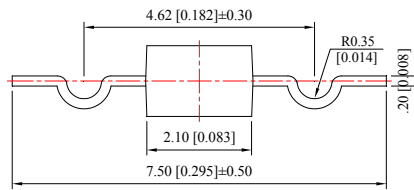
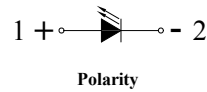
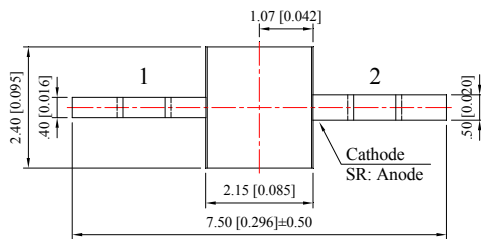

Recommended Soldering Pad Dimensions

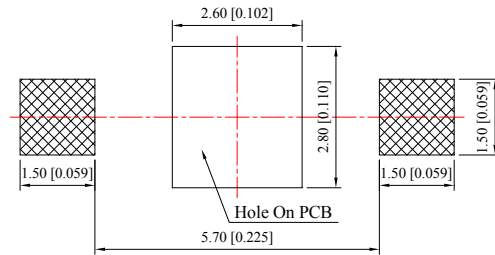

Notes:

1. All dimensions are in millimeters (inches).
2. Tolerance is ± 0.25 mm (.010") unless otherwise noted.

A21GC-2B-TR6

2.15x2.4mm, Yellow Green LED

Subminiature Axial Flat Top View Chip LED Indicator



Technical Data Sheet

Absolute Maximum Ratings at Ta=25°C

| Parameters | Symbol | Max | Unit |
|-------------------------------------|--------|---------------------|------|
| Power Dissipation | Pd | 60 | mW |
| Peak Forward Current ^(a) | IFP | 100 | mA |
| DC Forward Current ^(b) | IF | 25 | mA |
| Reverse Voltage | VR | 5 | V |
| Electrostatic Discharge (HBM) | ESD | 2000 | V |
| Operating Temperature Range | Topr | -40°C to +80°C | |
| Storage Temperature Range | Tstg | -40°C to +85°C | |
| Soldering Temperature | Tsld | 260°C for 5 Seconds | |

Notes:

- Derate linearly as shown in derating curve.
- Duty Factor = 10%, Frequency = 1 kHz

Electrical Optical Characteristics at Ta=25°C

| Parameters | Symbol | Min. | Typ. | Max. | Unit | Test Condition |
|------------------------------------|--------|------|------|------|------|----------------|
| Luminous Intensity ^(a) | IV | 20 | 40 | --- | mcd | IF=20mA |
| Viewing Angle ^(b) | 2θ1/2 | --- | 140 | --- | Deg | IF=20mA |
| Peak Emission Wavelength | λp | --- | 575 | --- | nm | IF=20mA |
| Dominant Wavelength ^(c) | λd | --- | 573 | --- | nm | IF=20mA |
| Spectral Line Half-Width | Δλ | --- | 20 | --- | nm | IF=20mA |
| Forward Voltage | VF | 1.60 | 2.00 | 2.40 | V | IF=20mA |
| Reverse Current | IR | --- | --- | 10 | μA | VR=5V |

Notes:

- Luminous intensity is measured with a light sensor and filter combination that approximates the CIE eye-response curve.
- 2θ1/2 is the o-axis angle where the luminous intensity is 1/2 the peak intensity
- The dominant wavelength (λd) is derived from the CIE chromaticity diagram and represents the single wavelength which defines the color of the device.

A21GC-2B-TR6

2.15x2.4mm, Yellow Green LED

Subminiature Axial Flat Top View Chip LED Indicator



Technical Data Sheet

Typical Electrical / Optical Characteristics Curves (25°C Ambient Temperature Unless Otherwise Noted)

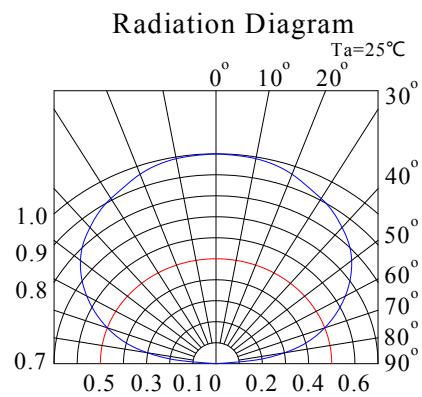
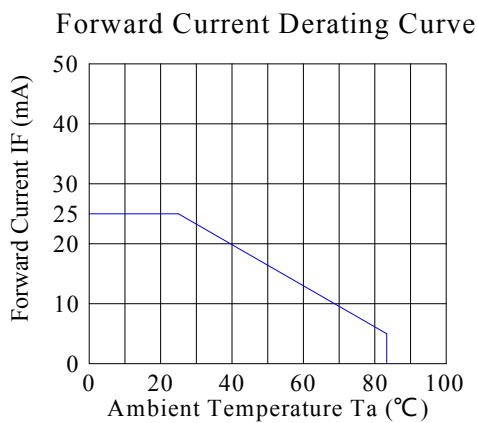
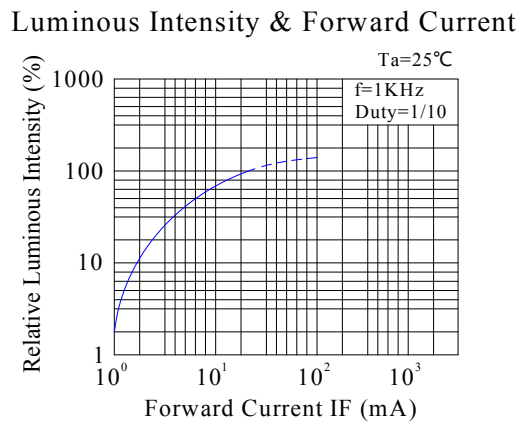
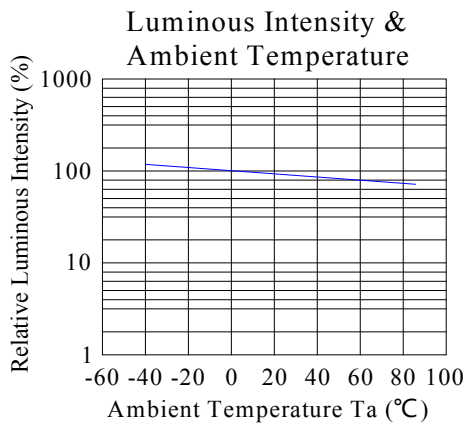
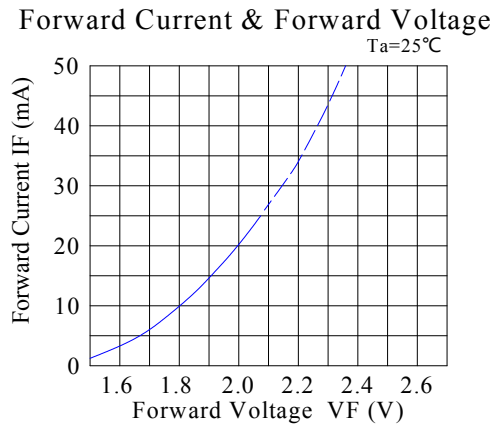
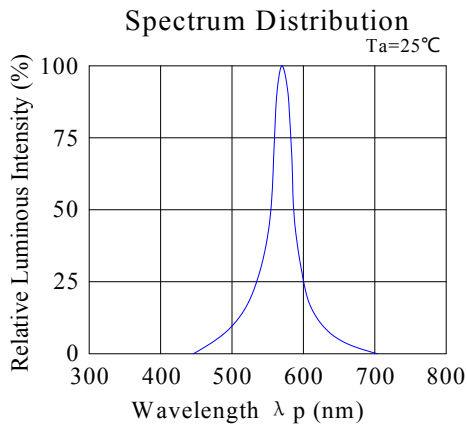

A21GC-2B-TR6

2.15x2.4mm, Yellow Green LED

Subminiature Axial Flat Top View Chip LED Indicator



Technical Data Sheet

Reel Dimensions:

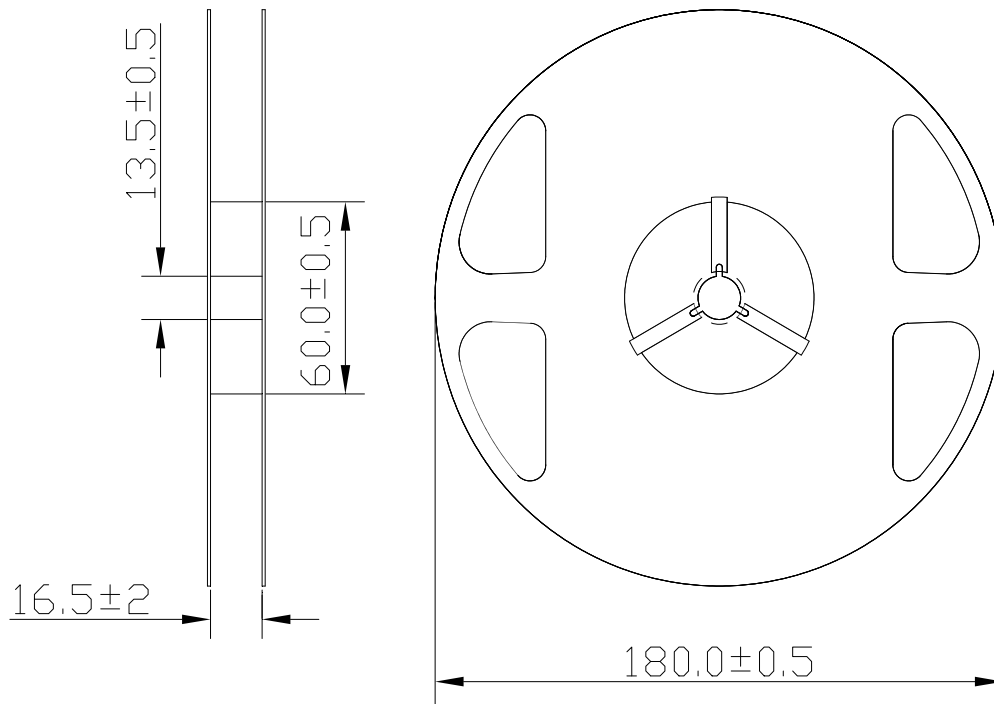

Carrier Tape Dimensions:

Loaded quantity 2500 pcs per reel.

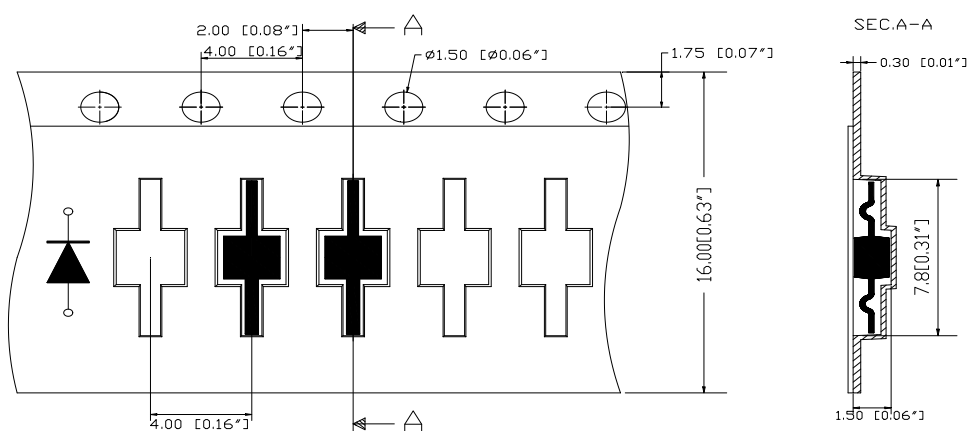

A21GC-2B-TR6

2.15x2.4mm, Yellow Green LED

Subminiature Axial Flat Top View Chip LED Indicator



Technical Data Sheet

Packing & Label Specifications:

Moisture Resistant Packaging:

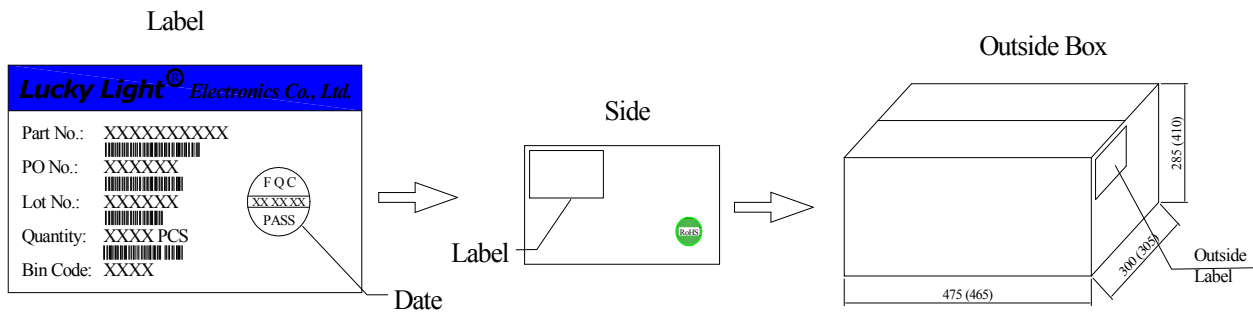
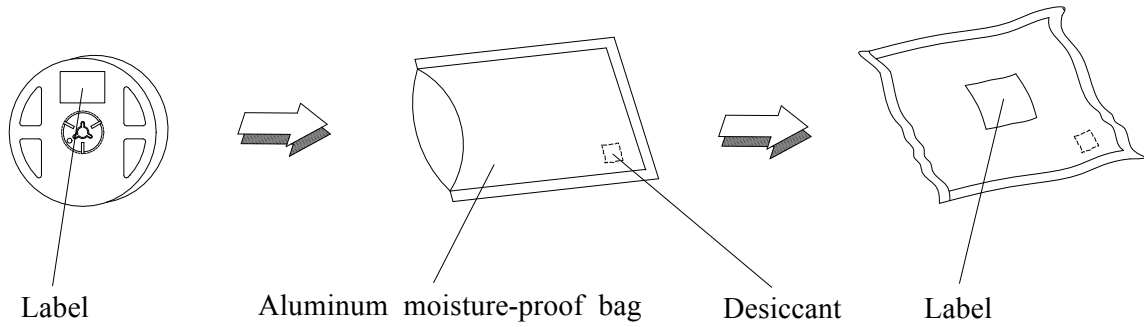

A21GC-2B-TR6

2.15x2.4mm, Yellow Green LED

Subminiature Axial Flat Top View Chip LED Indicator

LuckyLight

Technical Data Sheet

CAUTIONS

1. Handling Precautions:

- 1.1. Handle the component along the side surfaces by using forceps or appropriate tools.
- 1.2. Do not directly touch or handle the silicone lens surface. It may damage the internal circuitry.
- 1.3. Do not stack together assembled PCBs containing exposed LEDs. Impact may scratch the silicone lens or damage the internal circuitry.

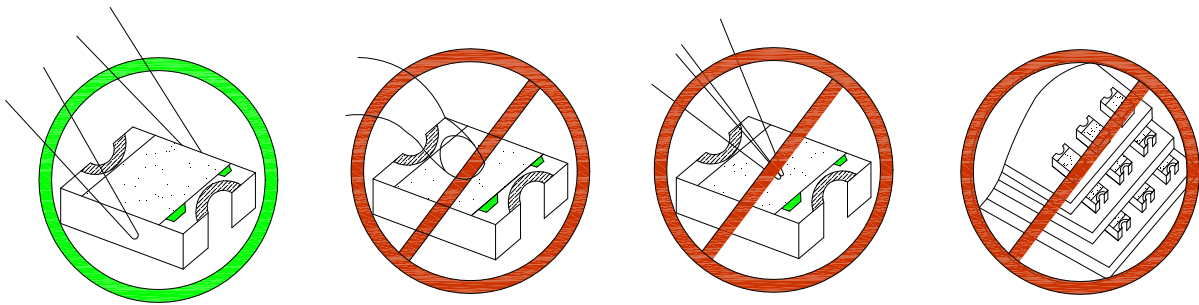

Compare to epoxy encapsulant that is hard and brittle, silicone is softer and flexible. Although its characteristic significantly reduces thermal stress, it is more susceptible to damage by external mechanical force. As a result, special handling precautions need to be observed during assembly using silicone encapsulated LED products. Failure to comply might lead to damage and premature failure of the LED.

2. Storage

- 2.1. Do not open moisture proof bag before the products are ready to use.
- 2.2. Before opening the package, the LEDs should be kept at 30°C or less and 60%RH or less.
- 2.3. The LEDs should be used within a year.
- 2.4. After opening the package, the LEDs should be kept at 30°C or less and 60%RH or less.
- 2.5. The LEDs should be used within 168 hours after opening the package.
- 2.6. If the moisture adsorbent material has fabled away or the LEDs have exceeded the storage time, baking treatment should be performed using the following conditions. Baking treatment: 65±5°C for 24 hours.

A21GC-2B-TR6

2.15x2.4mm, Yellow Green LED

Subminiature Axial Flat Top View Chip LED Indicator



Technical Data Sheet

3. Soldering Condition

3.1. Pb-free solder temperature profile

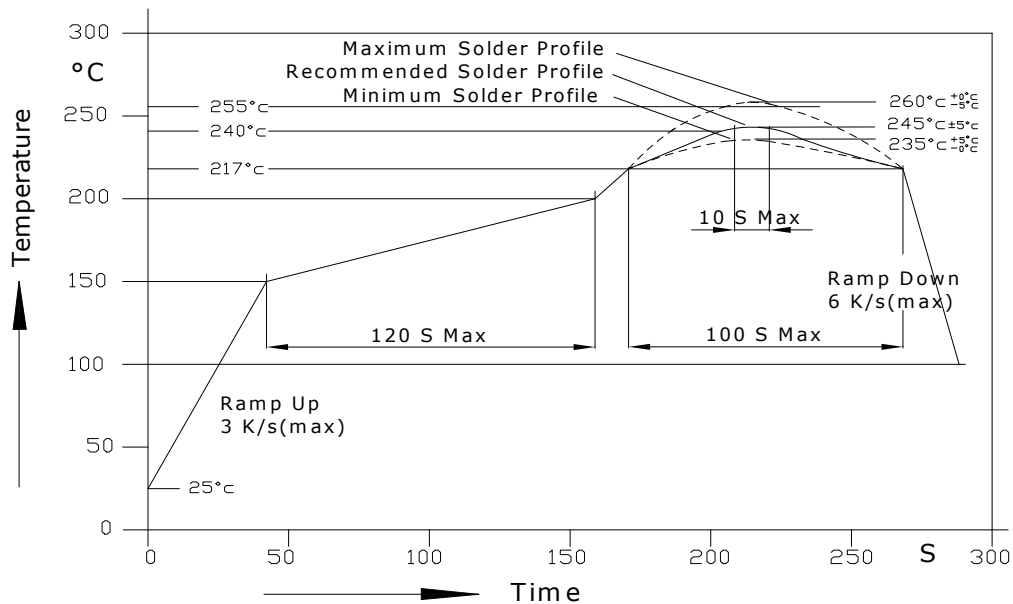

3.2. Reflow soldering should not be done more than two times.

3.3. When soldering, do not put stress on the LEDs during heating.

3.4. After soldering, do not warp the circuit board.

3.5. Recommended soldering conditions:

| Reflow soldering | | Soldering iron | |
|------------------|------------------------------|----------------|-----------------|
| Pre-heat | 150~200°C | Temperature | 300°C Max. |
| Pre-heat time | 120 sec. Max. | Soldering time | 3 sec. Max. |
| Peak temperature | 260°C Max. | | (one time only) |
| Soldering time | 10 sec. Max.(Max. two times) | | |

3.6. Because different board designs use different number and types of devices, solder pastes, reflow ovens, and

Technical Data Sheet

circuit boards, no single temperature profile works for all possible combinations.

However, you can successfully mount your packages to the PCB by following the proper guidelines and PCB-specific characterization.

4. Drive Method

4.1. An LED is a current-operated device. In order to ensure intensity uniformity on multiple LEDs connected in parallel in an application, it is recommended that a current limiting resistor be incorporated in the drive circuit, in series with each LED as shown in Circuit A below.

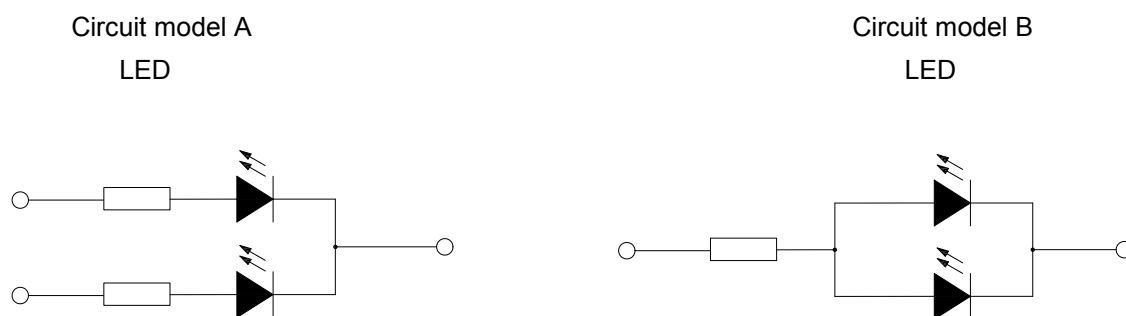

a. Recommended circuit.

b. The brightness of each LED might appear different due to the differences in the I-V characteristics of those LEDs.

Terms and conditions for the usage of this document

1. The information included in this document reflects representative usage scenarios and is intended for technical reference only.
2. The part number, type, and specifications mentioned in this document are subject to future change and improvement without notice. Before production usage customer should refer to the latest datasheet for the updated specifications.
3. When using the products referenced in this document, please make sure the product is being operated within the environmental and electrical limits specified in the datasheet. If customer usage exceeds the specified limits, LuckyLight will not be responsible for any subsequent issues.
4. The information in this document applies to typical usage in consumer electronics applications. If customer's application has special reliability requirements or have life-threatening liabilities, such as automotive or medical usage, please consult with LuckyLight representative for further assistance.
5. The contents and information of this document may not be reproduced or re-transmitted without permission by LuckyLight.