

C3535DUVC-QB-D

3.5×3.5mm, Deep UV LED

Surface Mount Sterilization LED

Technical Data Sheet

Features:

- High optical output power
- Long life and low light attenuation
- Environmental protection, energy saving and high reliability
- Durable, shock-proof, easy to design, suitable for multifield applications
- Built-in UVC wavelength chip, unique design and application more widely

Applications:

- Disinfection Sterilization.
- Ozone generator.
- QA equipment.
- Ultraviolet detection、communication technology
- Air sterilization, water sterilization
- Medical treatment and skin disease treatment

C3535DUVC-QB-D

3.5×3.5mm, Deep UV LED

Surface Mount Sterilization LED

Technical Data Sheet

Part No.	Emitting Color	Lens Color
C3535DUVC-QB-D	Deep UV	Quartz glass

Package Dimension:

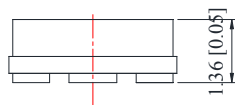
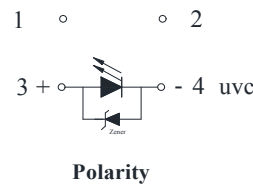
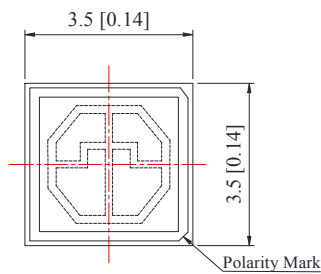

Recommended Soldering Pad Dimensions

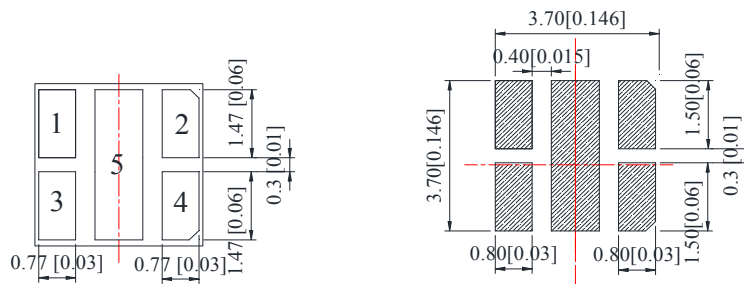

Notes:

1. All dimensions are in millimeters (inches).
2. Tolerance is ± 0.25 mm (.010") unless otherwise noted.

C3535DUVC-QB-D

3.5×3.5mm, Deep UV LED

Surface Mount Sterilization LED

LuckyLight

Technical Data Sheet

Absolute Maximum Ratings at Ta=25°C

Parameters	Symbol	Max.	Unit
Peak Forward Current ^(a)	I _{FP}	40	mA
DC Forward Current	I _F	30	mA
Junction Temperature	T _a	90	°C
Operating Temperature Range	T _{opr}	-40°C to +85°C	
Storage Temperature Range	T _{stg}	-40°C to +85°C	
Soldering Temperature	T _{slid}	260°C for 5 Seconds	

Note:

a. Pulse width ≤ 0.1ms, Duty ≤ 1/10

Electrical Optical Characteristics at Ta=25°C

Parameters	Symbol	Min.	Typ.	Max.	Unit	Test Condition
Radiant flux ^(a)	Φ _e	2.5	4.0	5.0	mW	IF=30mA
Viewing Angle	2θ _{1/2}	---	120	---	Deg	IF=30mA
Peak Emission Wavelength ^(b)	λ _p	270	275	280	nm	IF=30mA
Spectral Line Half-Width	Δλ	---	10	---	nm	IF=30mA
Thermal Resistance Junction To Board	R _{θJ-B}	---	10	---	°C/W	IF=30mA
Forward Voltage ^(c)	V _F	5.5	---	7.0	V	IF=30mA
Reverse Current	I _R	---	---	10	μA	VR=5V

Notes:

- Radiant flux measurement tolerance: ±10%.
- Wavelength measurement tolerance: ±1nm
- Forward voltage measurement tolerance: ±0.1V

Spec No.: C3535

Issue No.: G-Rev-4

LuckyLight Electronics Co., Ltd

Copyright © 2021 LuckyLight All Rights Reserved

Date: 22-Mar-2021

E-mail: sales@luckylight.cn

http:// www.luckylight.cn

Page: 3 / 9

C3535DUVC-QB-D

3.5×3.5mm, Deep UV LED

Surface Mount Sterilization LED



Technical Data Sheet

Typical Electrical / Optical Characteristics Curves (25°C Ambient Temperature Unless Otherwise Noted)

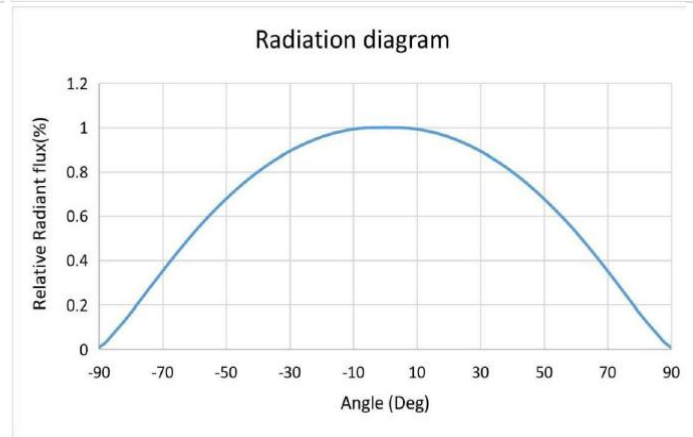
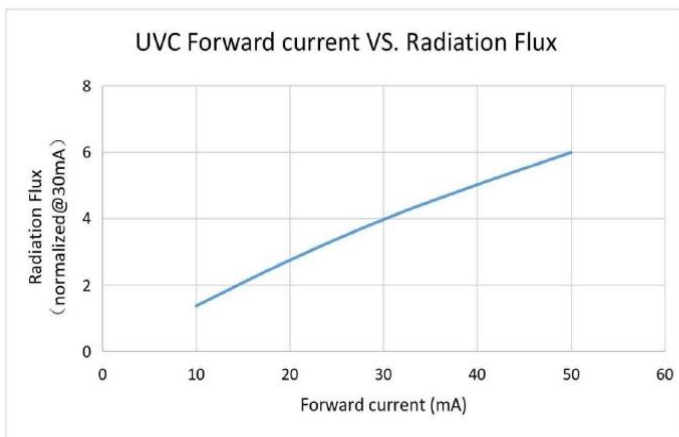
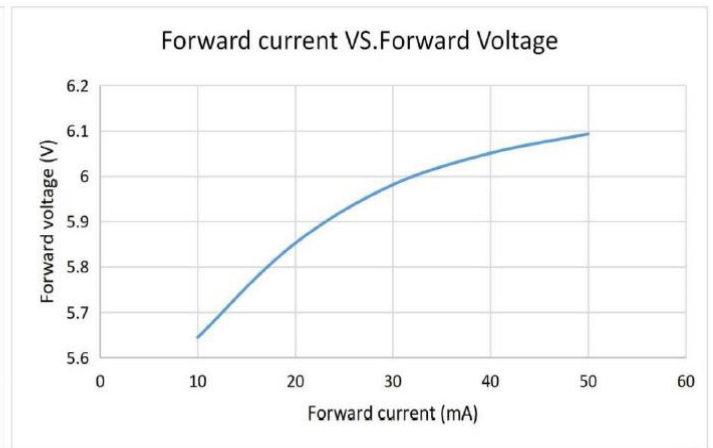
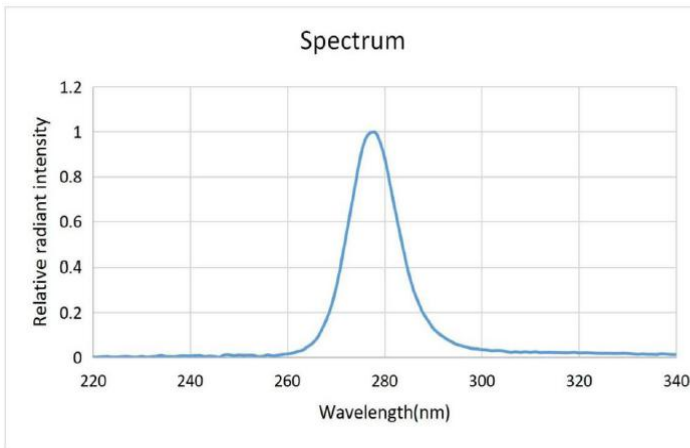

C3535DUVC-QB-D

3.5×3.5mm, Deep UV LED

Surface Mount Sterilization LED



Technical Data Sheet

Packing & Label Specifications:

Moisture Resistant Packaging:

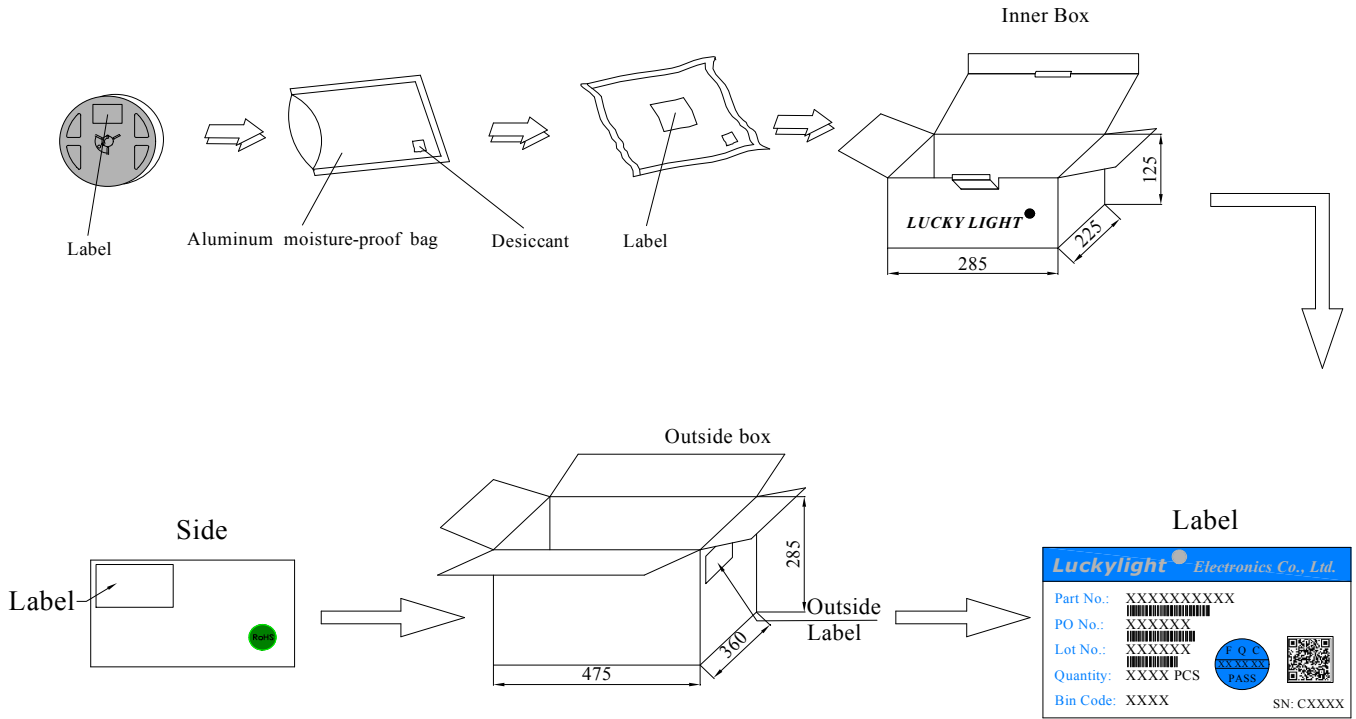

C3535DUVC-QB-D

3.5×3.5mm, Deep UV LED

Surface Mount Sterilization LED



Technical Data Sheet

Reel Dimensions:

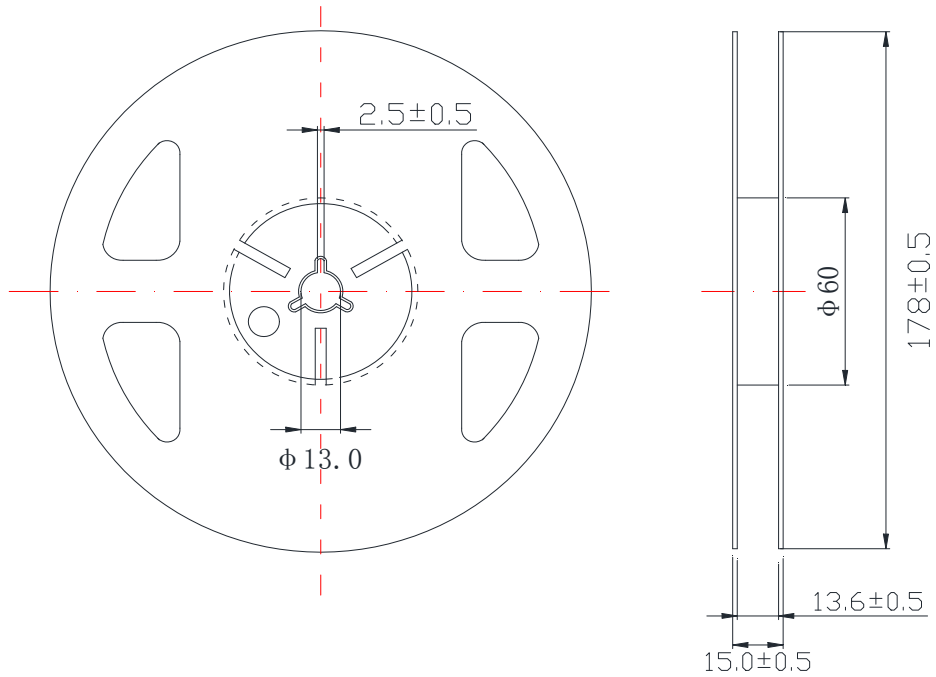

Carrier Tape Dimensions:

Loaded quantity 1000 PCS per reel.

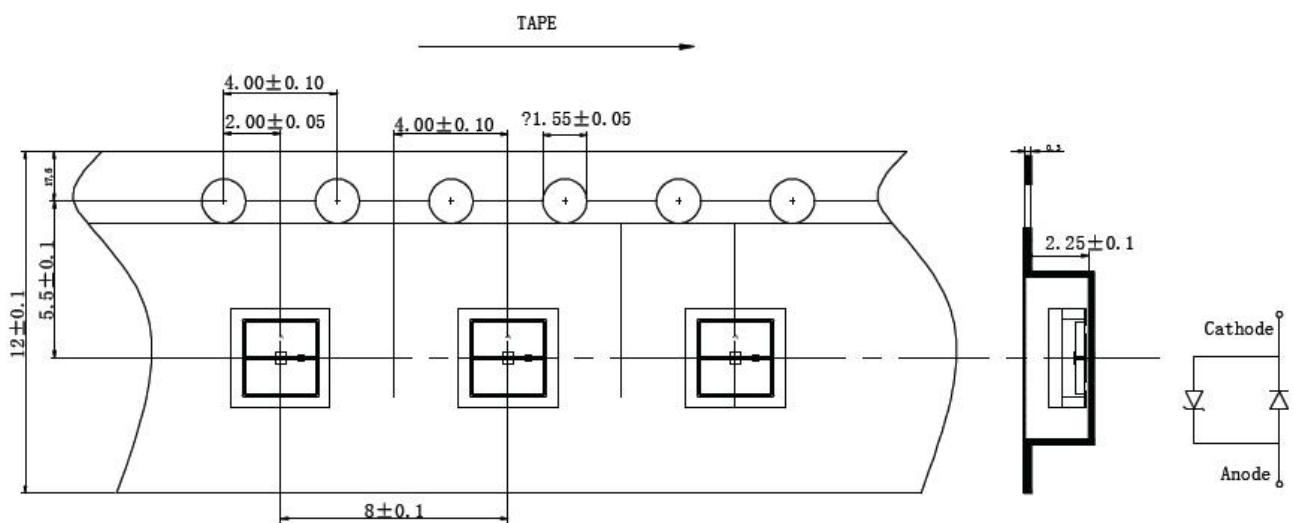

Spec No.: C3535

Issue No.: G-Rev-4

LuckyLight Electronics Co., Ltd

Copyright © 2021 LuckyLight All Rights Reserved

Date: 22-Mar-2021

E-mail: sales@luckylight.cn

http:// www.luckylight.cn

Page: 6 / 9

C3535DUVC-QB-D

3.5×3.5mm, Deep UV LED

Surface Mount Sterilization LED

Technical Data Sheet

CAUTIONS

1. Handling Precautions:

- 1.1 Handle the component along the side surfaces by using forceps or appropriate tools.
- 1.2 Do not directly touch or handle the silicone lens surface. It may damage the internal circuitry.
- 1.3 Do not stack together assembled PCBs containing exposed LEDs. Impact may scratch the silicone lens or damage the internal circuitry.

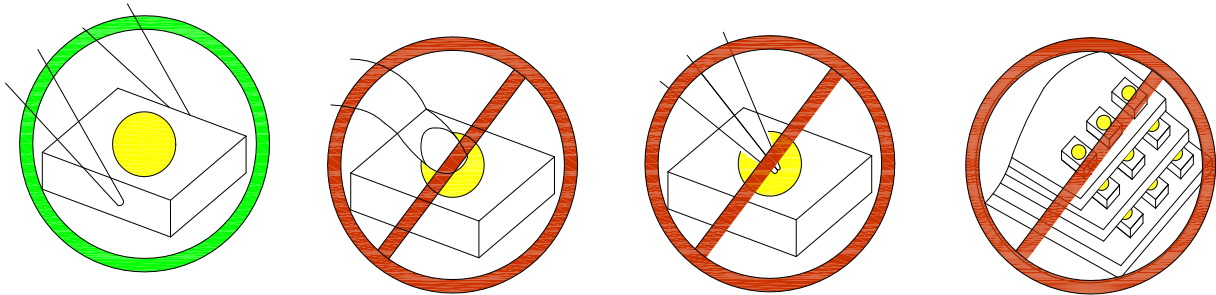

1.4 Compare to epoxy encapsulant that is hard and brittle, silicone is softer and flexible. Although its characteristic significantly reduces thermal stress, it is more susceptible to damage by external mechanical force. As a result, special handling precautions need to be observed during assembly using silicone encapsulated LED products. Failure to comply might lead to damage and premature failure of the LED.

2. Storage:

- 2.1 Do not open moisture proof bag before the products are ready to use.
- 2.2 Before opening the package, the LEDs should be kept at 30°C or less and 60%RH or less.
- 2.3 The LEDs should be used within a year.
- 2.4 After opening the package, the LEDs should be kept at 30°C or less and 60%RH or less.
- 2.5 The LEDs should be used within 24 hours after opening the package.
- 2.6 If the moisture adsorbent material has fabled away or the LEDs have exceeded the storage time, baking treatment should be performed using the following conditions. Baking treatment: 65±5°C for 24 hours.

C3535DUVC-QB-D

3.5×3.5mm, Deep UV LED

Surface Mount Sterilization LED



Technical Data Sheet

3. Soldering Condition:

3.1 Pb-free solder temperature profile.

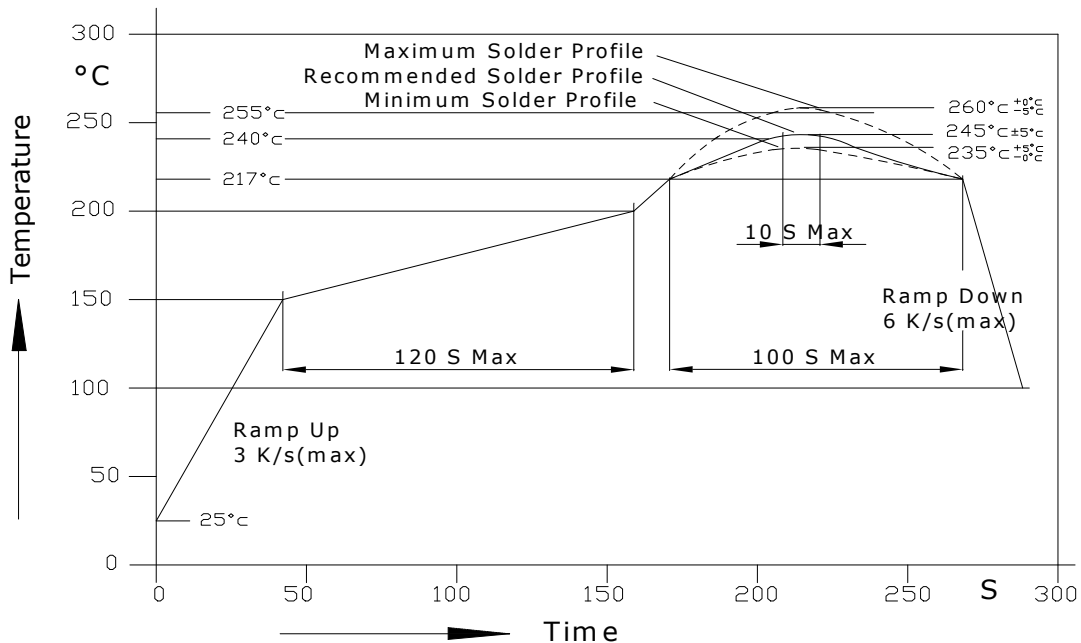

3.2 Reflow soldering should not be done more than two times.

3.3 When soldering, do not put stress on the LEDs during heating.

3.4 After soldering, do not warp the circuit board.

3.5 Recommended soldering conditions:

Reflow soldering		Soldering iron	
Pre-heat	150~200°C	Temperature	300°C Max.
Pre-heat time	120 sec. Max.	Soldering time	3 sec. Max.
Peak temperature	260°C Max.		(one time only)
Soldering time	10 sec. Max. (Max. two times)		

3.6 Because different board designs use different number and types of devices, solder pastes, reflow ovens, and circuit boards, no single temperature profile works for all possible combinations.

However, you can successfully mount your packages to the PCB by following the proper guidelines and PCB-specific characterization.

C3535DUVC-QB-D

3.5×3.5mm, Deep UV LED

Surface Mount Sterilization LED

Technical Data Sheet

4. Drive Method:

4.1 An LED is a current-operated device. In order to ensure intensity uniformity on multiple LEDs connected in parallel in an application, it is recommended that a current limiting resistor be incorporated in the drive circuit, in series with each LED as shown in Circuit A below.

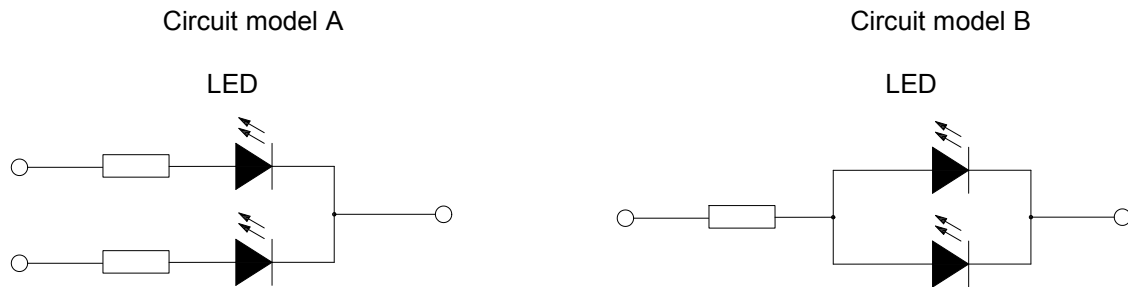

(A) Recommended circuit.

(B) The brightness of each LED might appear different due to the differences in the I-V characteristics of those LEDs.

Terms and conditions for the usage of this document:

1. The information included in this document reflects representative usage scenarios and is intended for technical reference only.
2. The part number, type, and specifications mentioned in this document are subject to future change and improvement without notice. Before production usage customer should refer to the latest datasheet for the updated specifications.
3. When using the products referenced in this document, please make sure the product is being operated within the environmental and electrical limits specified in the datasheet. If customer usage exceeds the specified limits, LuckyLight will not be responsible for any subsequent issues.
4. The information in this document applies to typical usage in consumer electronics applications. If customer's application has special reliability requirements or have life-threatening liabilities, such as automotive or medical usage, please consult with LuckyLight representative for further assistance.
5. The contents and information of this document may not be reproduced or re-transmitted without permission by LuckyLight.