

## HP70MWJ

8mm,3W White LED

3W Power LED Light Source



## Technical Data Sheet

---

### Features:

- long operating life
- Small footprint and low profile
- Energy efficient
- High current operation
- Silicone encapsulation
- Available in 2700K, 3000K, 3500K, 4000K, 5000K, 5700K, 6500K and 10000K
- The product itself will remain within RoHS compliant Version

### Descriptions:

- The HP70M series is available in Red, Orange, Yellow, Green, Blue and White. The White Power LED is available in the range of color temperature from 2700K to 10000K
- This 1W Power LED Light Source is a high energy efficient device which can handle high thermal and high driving current. The exposed pad design enables excellent heat transfer from the package to the motherboard
- The package design is suitable for a wide variety of applications especially where height is a constraint.

### Applications:

- Architectural lighting
- Channel backlighting
- Contour lighting
- Retail Display lighting
- Decorative lighting
- Garden lighting

# HP70MWJ

8mm,3W White LED

3W Power LED Light Source



## Technical Data Sheet

Part No.	Emitting Color
HP70MWJ	Cool White

### Package Dimension:

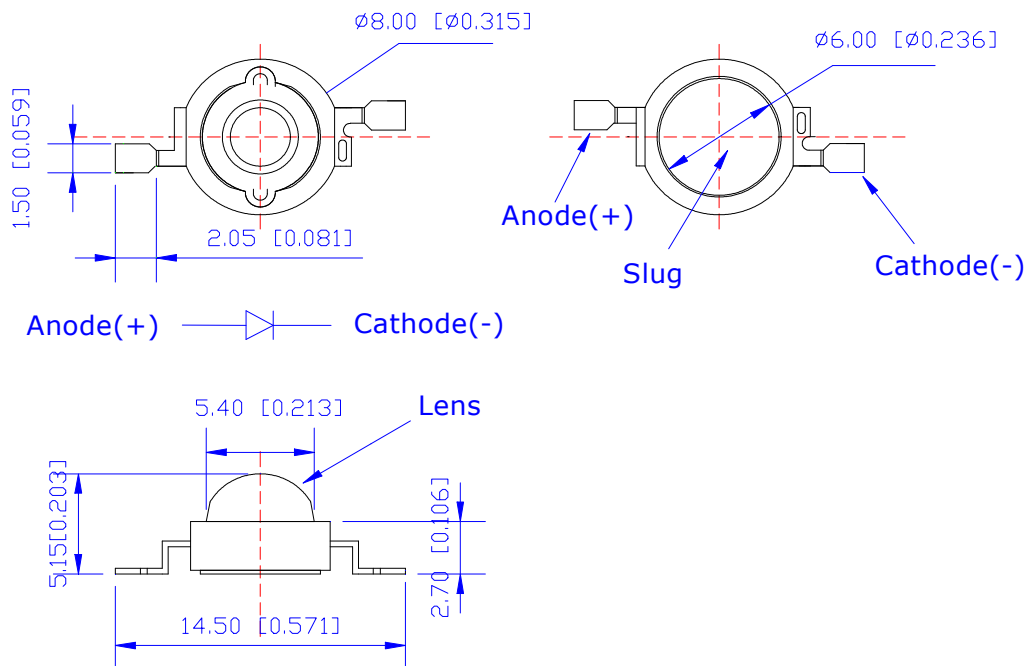

### Notes:

1. All dimensions are in millimeters (inches).
2. Tolerance is  $\pm 0.25$  mm (.010") unless otherwise noted.

# HP70MWJ

8mm,3W White LED

3W Power LED Light Source



## Technical Data Sheet

### Absolute Maximum Ratings at Ta=25°C

Parameters	Symbol	Max	Unit
Power Dissipation	Pd	2660	mW
Peak Forward Current <sup>(a)</sup>	IFP	1000	mA
DC Forward Current <sup>(b)</sup>	IF	700	mA
Reverse Voltage	VR	5	V
LED Junction Temperature	Tj	125	°C
Operating Temperature Range	Topr	-40°C to +85°C	
Storage Temperature Range	Tstg	-40°C to +80°C	

Notes:

a. Derate linearly as shown in derating curve.

b. Duty Factor = 10%, Frequency = 1 kHz

### Electrical Optical Characteristics at Ta=25°C

Parameters	Symbol	Min.	Typ.	Max.	Unit	Test Condition
Luminous Flux <sup>(a)</sup>	$\Phi_v$	180	220	---	lm	IF=700mA
Viewing Angle <sup>(b)</sup>	2 $\theta$ 1/2	---	135	---	Deg	IF=700mA
Chromaticity Coordinates <sup>(c)</sup>	x	---	0.31	---		IF=700mA
	y	---	0.32	---		
Color Temperature	CCT	5000	6500	---	K	IF=700mA
Color Rendering Index	CRI	70	---	---	Ra	IF=700mA
Forward Voltage	VF	2.80	3.40	3.80	V	IF=700mA
Reverse Current	IR	---	---	50	$\mu$ A	VR=5V

Notes:

a. ALuminous intensity is measured with a light sensor and filter combination that approximates the CIE eye-response curve.

b. 2 $\theta$ 1/2 is the  $\theta$ -axis angle where the luminous intensity is 1/2 the peak intensity

c. The dominant wavelength ( $\lambda_d$ ) is derived from the CIE chromaticity diagram and represents the single wavelength which defines the color of the device.

Spec No.: HP70M

Date: 12-Sep-2017

Issue No.: G-Rev-4

E-mail: sales@luckylight.cn

LuckyLight Electronics Co., Ltd

http:// www.luckylight.cn

Copyright © 2017 LuckyLight All Rights Reserved

Page: 3 / 8

# HP70MWJ

8mm,3W White LED

3W Power LED Light Source



## Technical Data Sheet

### Typical Electrical / Optical Characteristics Curves (25°C Ambient Temperature Unless Otherwise Noted)

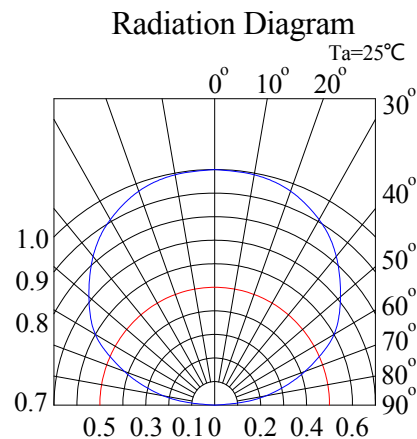
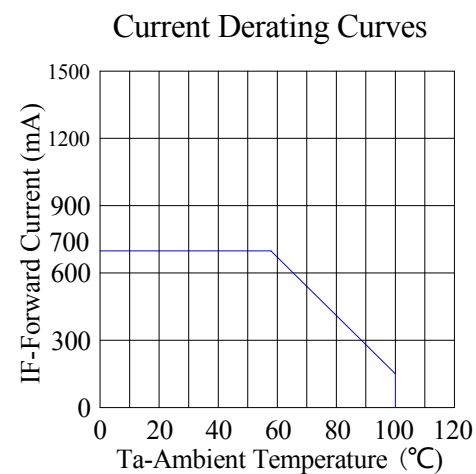
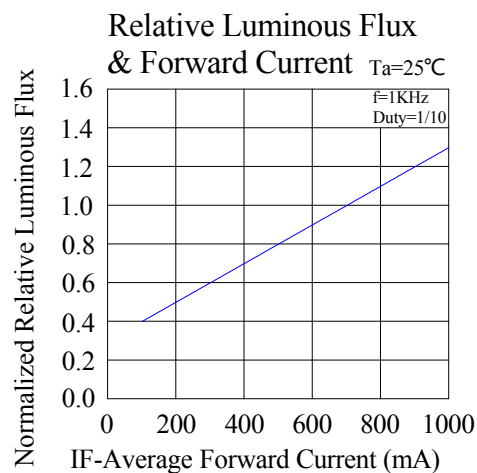
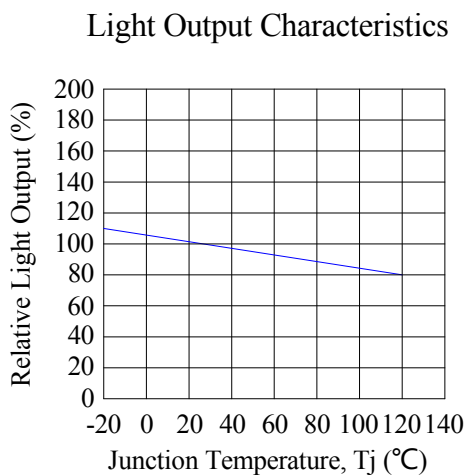
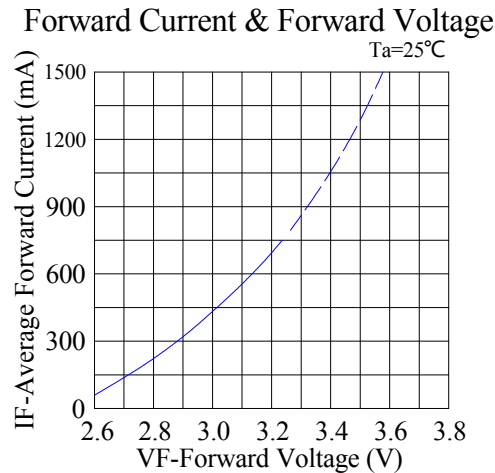
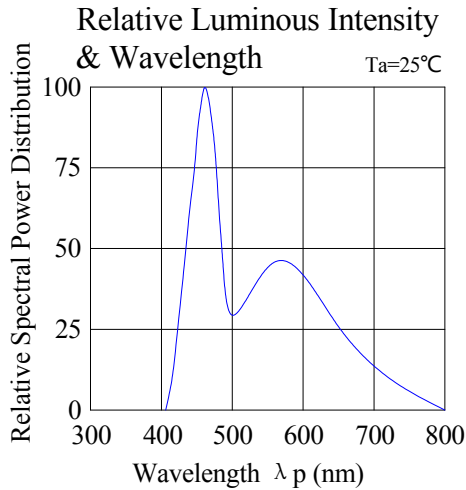

# HP70MWJ

8mm,3W White LED

3W Power LED Light Source



## Technical Data Sheet

### CIE 1931 Chromaticity Diagram:

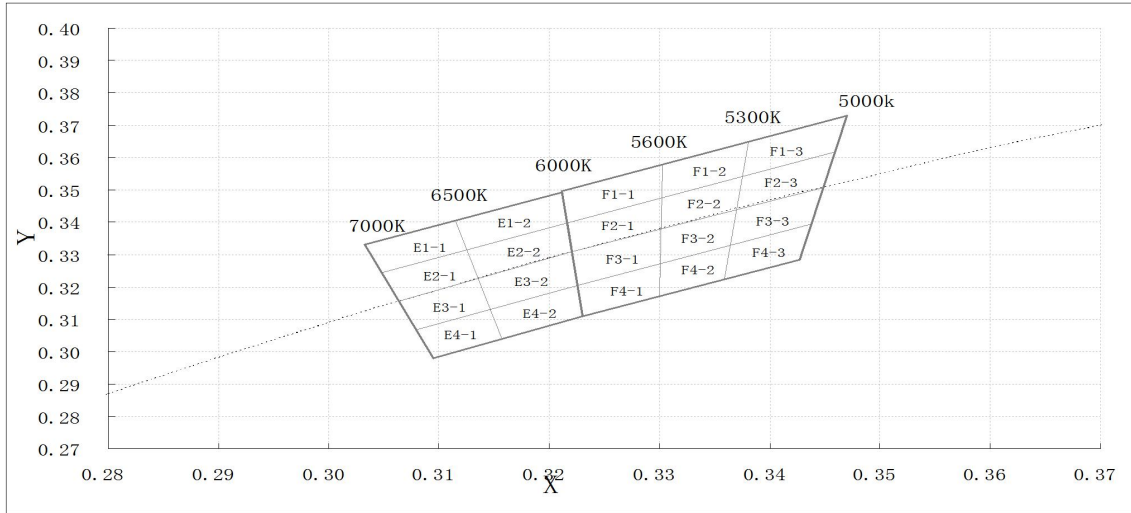

### Chromaticity Coordinates Specifications for Bin Rank:

Bin Code	Left x	Left y	Top x	Top y	Right x	Right y	Bottom x	Bottom y
E1-1	0.305	0.324	0.313	0.331	0.312	0.341	0.303	0.333
E2-1	0.306	0.316	0.314	0.323	0.313	0.331	0.305	0.324
E3-1	0.308	0.307	0.315	0.313	0.314	0.323	0.306	0.316
E4-1	0.310	0.298	0.316	0.304	0.315	0.313	0.308	0.307
E1-2	0.313	0.331	0.323	0.340	0.323	0.349	0.312	0.341
E2-2	0.314	0.323	0.323	0.330	0.323	0.340	0.313	0.331
E3-2	0.315	0.313	0.323	0.321	0.323	0.330	0.314	0.323
E4-2	0.316	0.304	0.323	0.311	0.323	0.321	0.315	0.313
F1-1	0.323	0.340	0.330	0.347	0.330	0.357	0.323	0.349
F2-1	0.323	0.330	0.330	0.337	0.330	0.347	0.323	0.340
F3-1	0.323	0.321	0.330	0.327	0.330	0.337	0.323	0.330
F4-1	0.323	0.311	0.330	0.317	0.330	0.327	0.323	0.321
F1-2	0.330	0.347	0.337	0.354	0.338	0.365	0.330	0.357
F2-2	0.330	0.337	0.337	0.343	0.337	0.354	0.330	0.347
F3-2	0.330	0.327	0.337	0.333	0.337	0.343	0.330	0.337
F4-2	0.330	0.317	0.337	0.322	0.337	0.333	0.330	0.327
F1-3	0.337	0.354	0.346	0.362	0.347	0.373	0.338	0.365
F2-3	0.337	0.343	0.345	0.351	0.346	0.362	0.337	0.354
F3-3	0.337	0.333	0.344	0.340	0.345	0.351	0.337	0.343
F4-3	0.337	0.322	0.343	0.328	0.344	0.340	0.337	0.333

Notes:

1. Color coordinates measurement allowance is  $\pm 0.15$ .
2. One delivery will include up to two consecutive color ranks and three luminous intensity ranks of the products the quantity-ratio of the ranks is decided by **LuckyLight**.

Spec No.: HP70M

Date: 12-Sep-2017

Issue No.: G-Rev-4

E-mail: sales@luckyLight.cn

LuckyLight Electronics Co., Ltd

http:// www.luckyLight.cn

Copyright © 2017 LuckyLight All Rights Reserved

Page: 5 / 8

## HP70MWJ

8mm,3W White LED

3W Power LED Light Source

# LuckyLight

## Technical Data Sheet

---

### Packing Standard:

Normal packing weight: 0.041kg/each tube ,0.877kg/1K

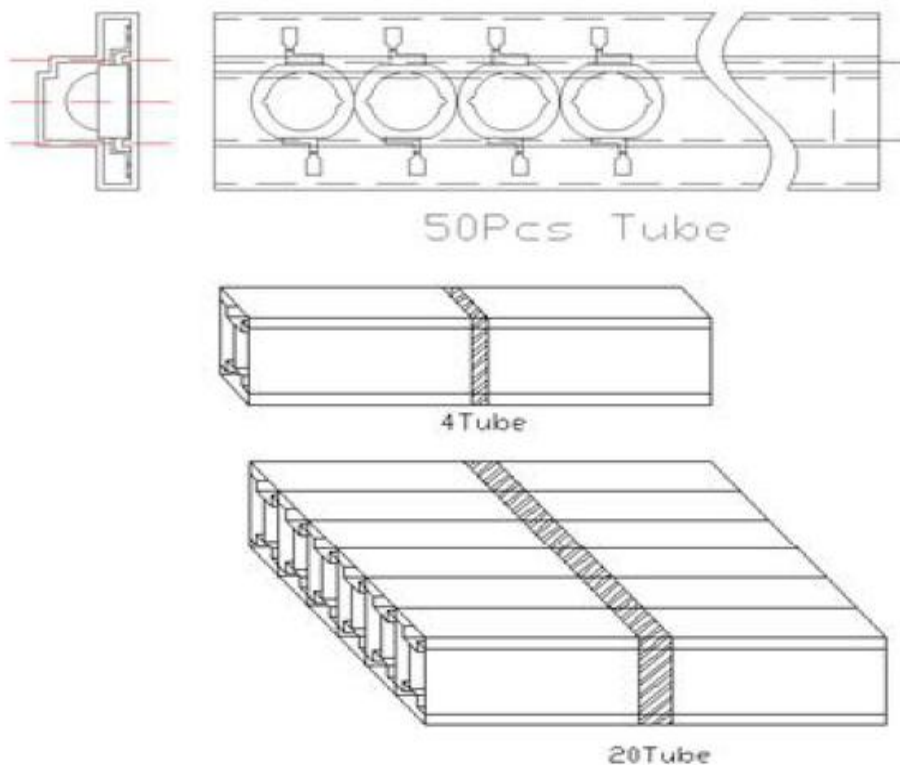

---

Spec No.: HP70M

Date: 12-Sep-2017

Issue No.: G-Rev-4

E-mail: sales@luckyLight.cn

LuckyLight Electronics Co., Ltd

http:// www.luckyLight.cn

Copyright © 2017 LuckyLight All Rights Reserved

Page: 6 / 8

## HP70MWJ

8mm,3W White LED

3W Power LED Light Source



## Technical Data Sheet

---

### CAUTIONS

#### 1.Storage:

To avoid moisture, we recommend storage conditions for the unopened LED +5 ~ +30 °C, relative humidity <60%. LED should be used within 24 Hrs. of opening the package. Please make sure to dehumidify and vacuum pack the remaining/ unused LED. Dehumidifying condition: +60 °C ± 5 °C, 12 Hrs. Effective age for the sealed led is one year.

#### 2.The assembly notes:

Soldering Conditions: Reflow soldering is recommended for this LED, the maximum temperature of reflow should not exceed 210°C (when using at 700mA, please adopt the soldering operation mode with copper pad at the bottom. Please consider the life time risk if use the thermal conductive resin with Copper pad at the bottom ). If hand soldering, set soldering iron temperature at 350°C and soldering time not More than 3 seconds, after the first soldering, make sure the substrate surface temperature returns to ambient temperature before a second soldering. Do not bend the LED PCB after soldering. Use recommended cleaning agent for PCB cleaning (Should not be use directly in the fluid) Please make sure when soldering, there is no external force on the soldering surface (such as pressure, friction or sharp metal nails, etc.), to avoid gold wire deformation or damage and other abnormalities.

If beyond recommended conditions, we cannot guarantee the LED stability, please do the risk assessment first.

#### 3.Anti-Static Measures:

Please take adequate measures to prevent electrostatic generation, such as wearing electrostatic ring or anti-static fingerstall etc; any relative products like plant equipment, machinery, carrier and transportation units shall be connected to discharging unit/ ground. After assembly, please make sure to discharge Static Electricity with proper ESD equipment.

#### 4.Temperature Control:

Recommended temperature conditions for enhanced product life: The temperature of copper pad is <75°C . During assembly, please ensure that a good quality thermal paste is applied and distributed evenly over the surface. While using thermal pad (Heat Sink), make sure LED is firmly tightened and there is no gap between surfaces. This product Heating conditions, tested at 500V with medium surface contact.

#### 5.drive control:

Drive this product at constant current. Output current range specifications should be according to the operational and other conditions, as mentioned in data sheet. Before using a constant voltage source or altered specifications, other than recommended, please consider risk factors.

#### 6.Other:

- Product is not suitable to use in following conditions;
- Direct or indirect wet / damp conditions, such as rain, etc;
- in contact with sea water and erosive materials;

## HP70MWJ

8mm,3W White LED

3W Power LED Light Source

# LuckyLight

### Technical Data Sheet

---

—Exposed to corrosive gases (e.g., Cl<sub>2</sub>, H<sub>2</sub>S, NH<sub>3</sub>, SO<sub>x</sub>, NO<sub>x</sub>, etc.);

—Exposed to dust, liquids or oils;



#### Terms and conditions for the usage of this document:

1. The information included in this document reflects representative usage scenarios and is intended for technical reference only.
2. The part number, type, and specifications mentioned in this document are subject to future change and improvement without notice. Before production usage customer should refer to the latest datasheet for the updated specifications.
3. When using the products referenced in this document, please make sure the product is being operated within the environmental and electrical limits specified in the datasheet. If customer usage exceeds the specified limits, LuckyLight will not be responsible for any subsequent issues.
4. The information in this document applies to typical usage in consumer electronics applications. If customer's application has special reliability requirements or have life-threatening liabilities, such as automotive or medical usage, please consult with LuckyLight representative for further assistance.
5. The contents and information of this document may not be reproduced or re-transmitted without permission by LuckyLight.

---

Spec No.: HP70M

Date: 12-Sep-2017

Issue No.: G-Rev-4

E-mail: sales@luckylight.cn

LuckyLight Electronics Co., Ltd

http:// www.luckylight.cn

Copyright © 2017 LuckyLight All Rights Reserved

Page: 8 / 8