

## KA2-541ABB / KA2-541CBB

0.54-inch (13.80 mm) 2-Digit 14-Segment Alphanumeric Display  
Blue Through-Hole Dual-Digit LED Alphanumeric Display

### Technical Data Sheet

---

#### Features

- High reliability
- Low power consumption
- Mechanically rugged and durable
- Excellent character appearance
- Easy mounting on PC boards or socket
- Stable performance under vibration and shock
- RoHS compliant

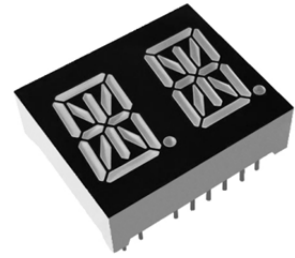

#### Descriptions

KA2-541ABB and KA2-541CBB are dual-digit blue 14-segment alphanumeric LED displays with a character height of 0.54-inch (13.80 mm). KA2-541ABB adopts a common anode configuration, while KA2-541CBB uses a common cathode configuration. Designed for readability at distances up to approximately 7 meters, these display deliver excellent reliability under bright ambient lighting.

The standard version features white segments on a black surface. An optional version with white segments on a gray surface is also available upon request.

#### Applications

- **Consumer Electronics:** Home appliances, Game console systems
- **Industrial Equipment:** Instrumentation panels, Panel meters, Test and measurement, Control systems
- **Commercial Terminals:** Point-of-sale terminals
- **General Use:** Alphanumeric readout displays

#### Device Selection Guide

Part No.	Emitting Color	Circuit Type
KA2-541ABB	Blue	Common Anode
KA2-541CBB	Blue	Common Cathode

# KA2-541ABB / KA2-541CBB



0.54-inch (13.80 mm) 2-Digit 14-Segment Alphanumeric Display  
Blue Through-Hole Dual-Digit LED Alphanumeric Display

## Technical Data Sheet

### Package Dimension

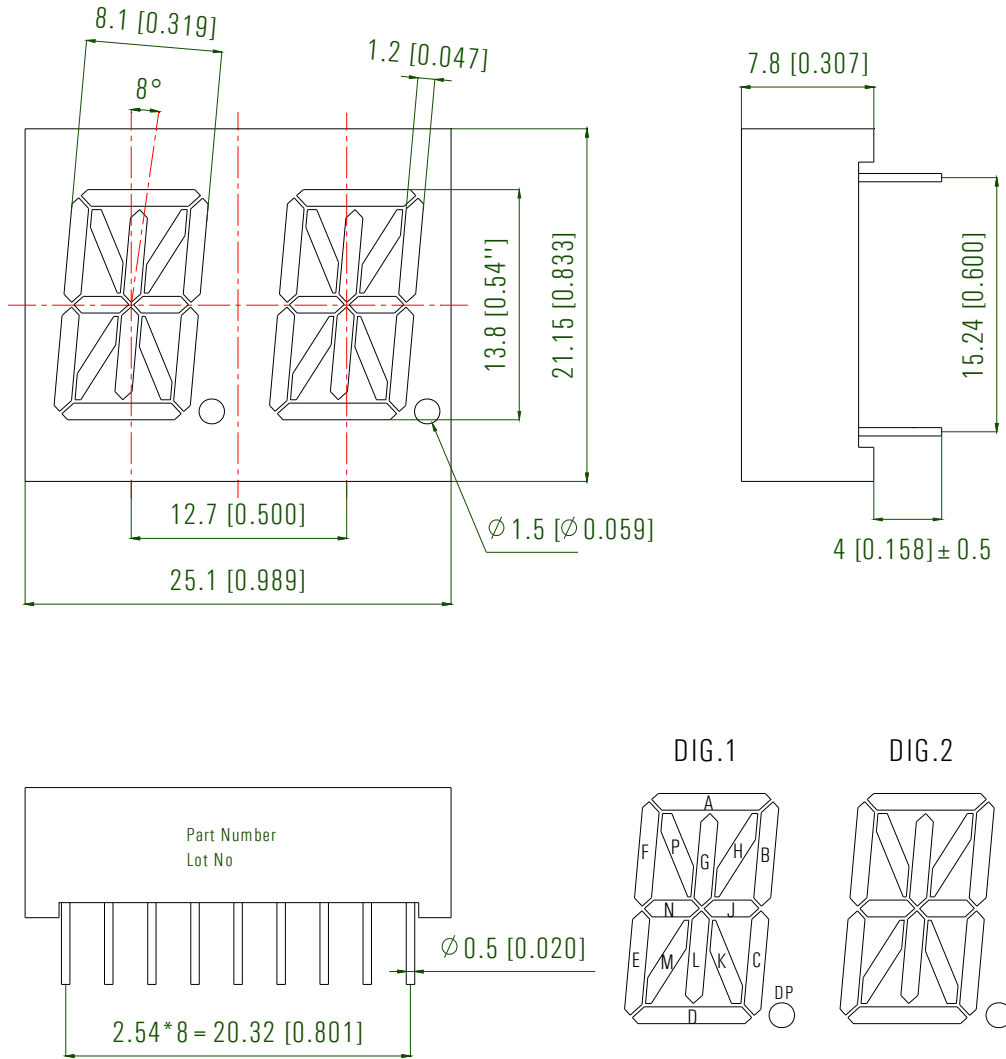

### Notes:

1. All dimensions are in millimeters (inches).
2. Tolerance is ± 0.25mm (.010") unless otherwise noted.
3. The specifications, characteristics and technical data described in the datasheet are subject to change without prior notice.

# KA2-541ABB / KA2-541CBB



0.54-inch (13.80 mm) 2-Digit 14-Segment Alphanumeric Display

Blue Through-Hole Dual-Digit LED Alphanumeric Display

## Technical Data Sheet

### Internal Circuit Diagram

#### KA2-541ABB (Common Anode)

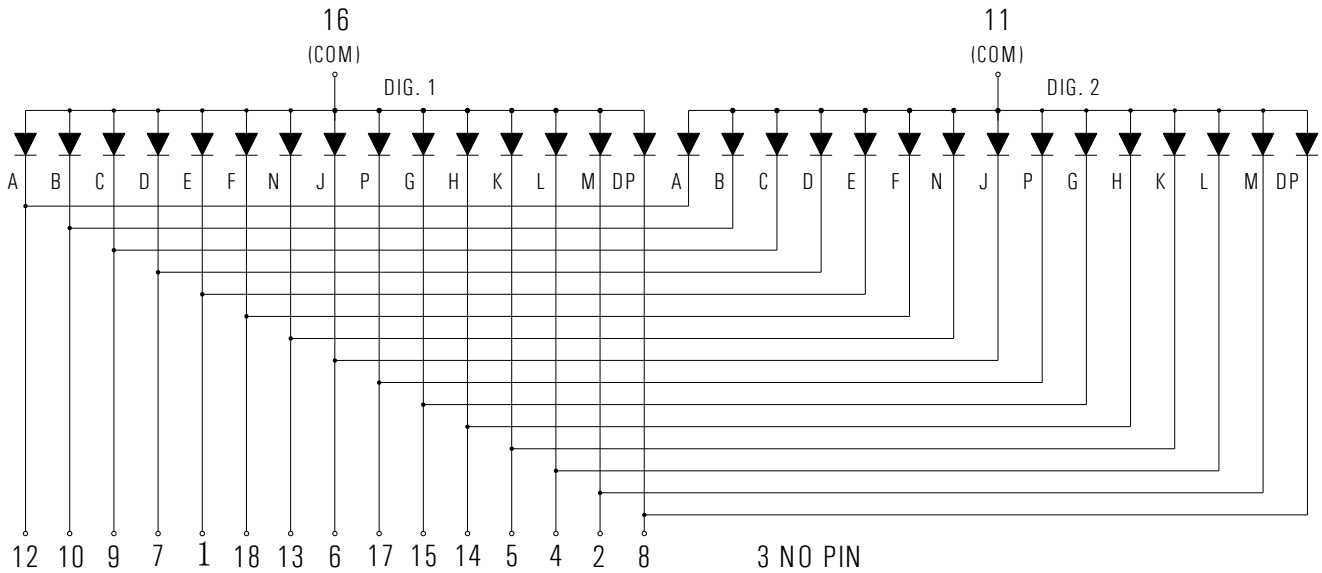

#### KA2-541CBB (Common Cathode)

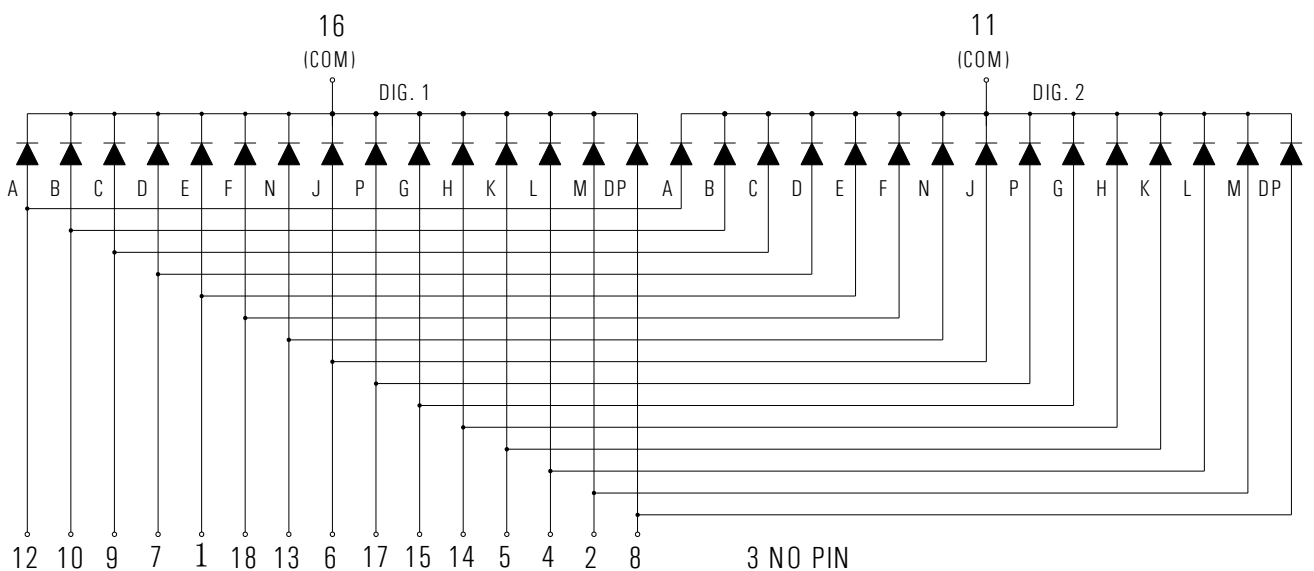

# KA2-541ABB / KA2-541CBB

0.54-inch (13.80 mm) 2-Digit 14-Segment Alphanumeric Display  
Blue Through-Hole Dual-Digit LED Alphanumeric Display

## Technical Data Sheet

### Pin Connection

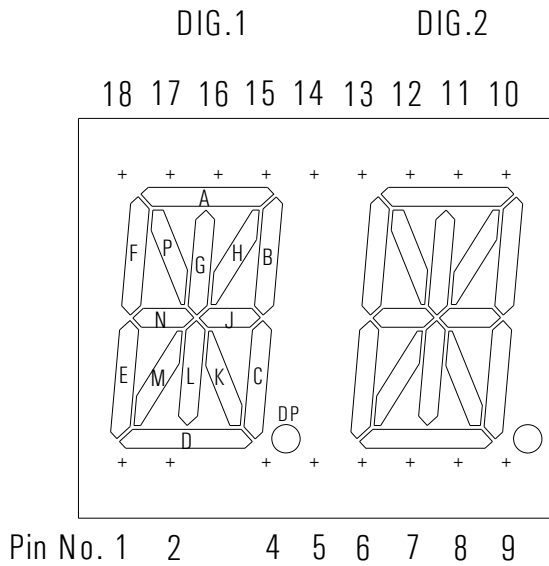

Pin No.	Function
1	Segment E
2	Segment M
3	No Pin
4	Segment L
5	Segment K
6	Segment J
7	Segment D
8	DP
9	Segment C
10	Segment B
11	Digit 2 Common
12	Segment A
13	Segment N
14	Segment H
15	Segment G
16	Digit 1 Common
17	Segment P
18	Segment F

### Recommended PCB Layout

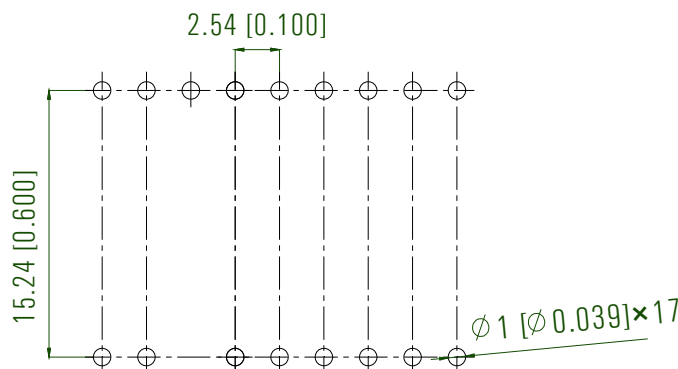

Absolute Maximum Ratings at  $T_A=25^{\circ}\text{C}$ 

Parameters	Symbol	Max	Unit
Power Dissipation (Per Chip)	$P_D$	64	mW
Peak Forward Current (Per Segment) (1/10 Duty Cycle, 0.1ms Pulse Width)	$I_{FP}$	40	mA
Forward Current (Per Segment)	$I_F$	20	mA
Reverse Voltage (Per Chip)	$V_R$	5	V
Operating Temperature Range	$T_{opr}$	-40°C to +80°C	
Storage Temperature Range	$T_{stg}$	-40°C to +85°C	
Soldering Temperature	$T_{sld}$	260°C for 5 Seconds	

Electrical Optical Characteristics at  $T_A=25^{\circ}\text{C}$ 

Parameters	Symbol	Min.	Typ.	Max.	Unit	Test Condition
Average Luminous Intensity	$I_v$	4.8	9.5	---	mcd	IF=5mA (Note a)
		9.5	19.0	---	mcd	IF=10mA (Note a)
Luminous Intensity Matching Ratio	$I_{v-m}$	---	---	2:1		IF=10mA
Peak Emission Wavelength	$\lambda_p$	---	468	---	nm	IF=10mA
Dominant Wavelength	$\lambda_d$	---	470	---	nm	IF=10mA (Note b)
Spectral Line Half-Width	$\Delta\lambda$	---	20	---	nm	IF=10mA
Forward Voltage (Per Segment)	$V_F$	---	2.8	3.2	V	IF=10mA (Note c)
Reverse Current (Per Segment)	$I_R$	---	---	50	$\mu\text{A}$	VR=5V

## Notes:

- Luminous intensity is measured with a light sensor and filter combination that approximates the CIE eye-response curve. Tolerance of Luminous Intensity:  $\pm 10\%$ .
- The dominant wavelength ( $\lambda_d$ ) is derived from the CIE chromaticity diagram and represents the single wavelength which defines the color of the device.
- Tolerance of Forward Voltage:  $\pm 0.1\text{V}$ .

**Typical Electrical/Optical Characteristic Curves at  $T_A = 25^\circ\text{C}$**

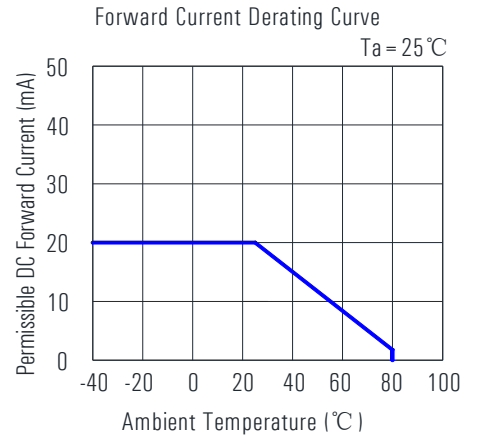
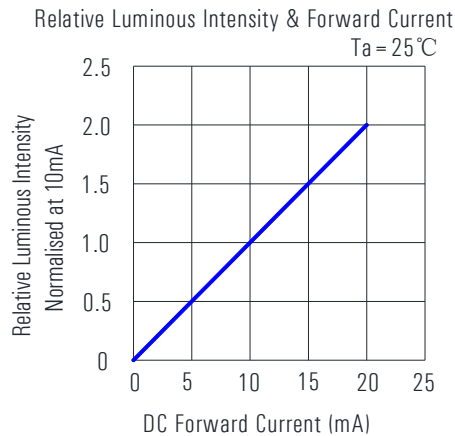
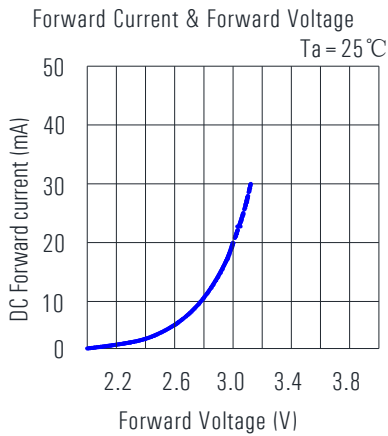
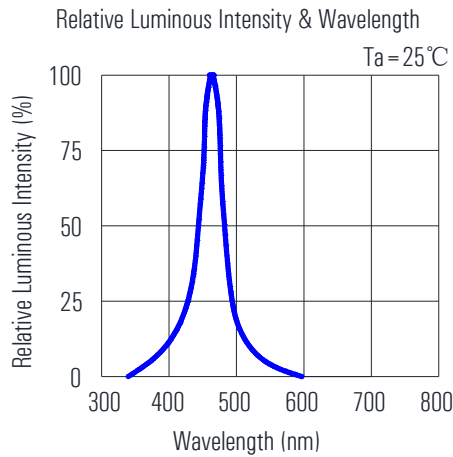

# KA2-541ABB / KA2-541CBB



0.54-inch (13.80 mm) 2-Digit 14-Segment Alphanumeric Display  
Blue Through-Hole Dual-Digit LED Alphanumeric Display

## Technical Data Sheet

### Packing & Label Specifications

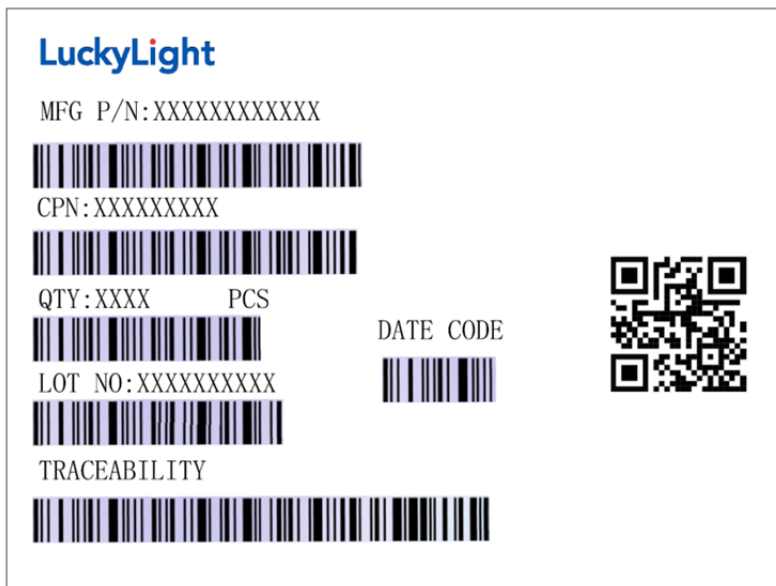
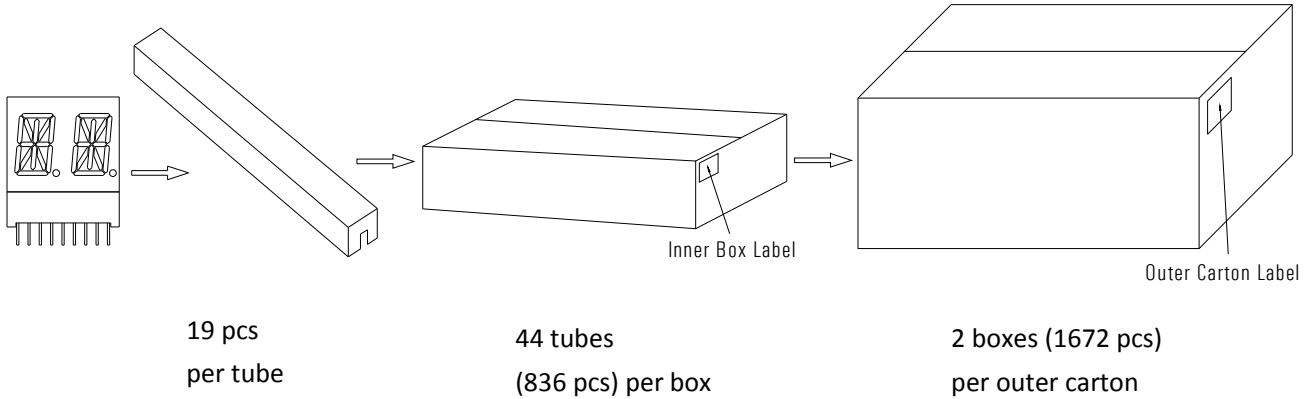

#### Notes:

1. The above "Packing & Label Specifications" refer to bag packaging and are for reference only.
2. Bag packaging will be used for through-hole LED digital displays with character heights exceeding 0.8 inches.
3. LuckyLight through-hole LED digital displays offer three packaging options: tube, bag, and box. If customers have special packaging requirements, please confirm the required packaging method with the salesperson in advance when placing an order.

## Precautions

### Through Hole Digital Display Mounting Method

#### 1. Lead Forming

- 1.1. Do not bend the component leads by hand without proper tools.
- 1.2. The leads should be bent by clinching the upper part of the lead firmly so that the bending force is not exerted on the plastic body.

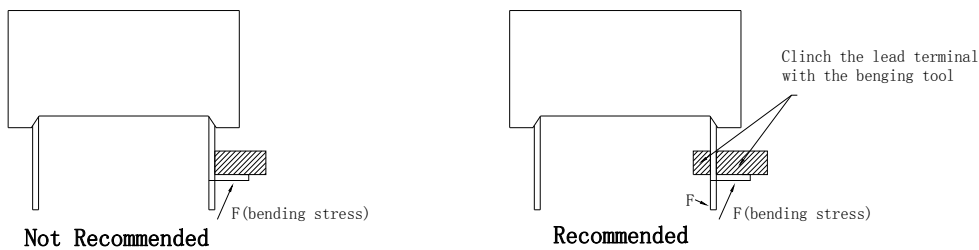

#### 2. Installation

- 2.1. The installation process should not apply stress to the lead terminals.
- 2.2. When inserting for assembly, ensure the terminal pitch matches the substrate board's hole pitch to prevent spreading or pinching of the lead terminals.



- 2.3. The component shall be placed at least 5mm from the edge of the PCB to avoid damage caused by excessive heat during wave soldering.

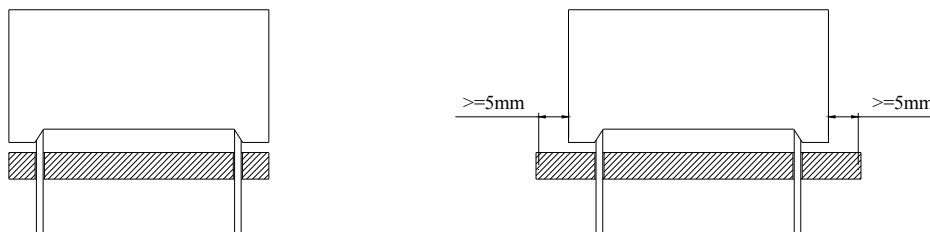

### 3.Recommended Wave Soldering Profiles

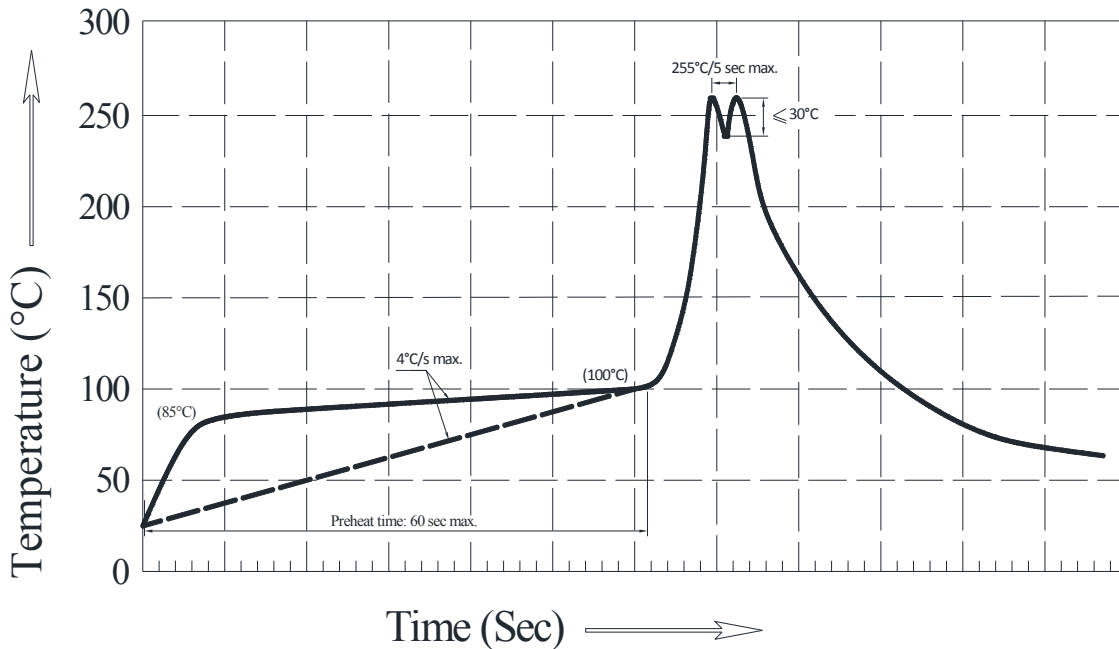
**Notes:**

- 3.1.It is recommended to pre-heat at a temperature of 105°C or lower (measured using a thermocouple attached to the LED pins) before immersion in the solder wave, with a maximum solder bath temperature of 260°C.
- 3.2. The peak wave soldering temperature should be between 245°C to 255°C for 3 seconds (maximum of 5 seconds).
- 3.3. Avoid applying stress to the epoxy resin when the temperature exceeds 85°C.
- 3.4.Fixtures should not exert stress on the component during mounting and soldering processes.
- 3.5. Only one wave soldering pass is allowed.
- 3.6.Maintain the PCB top-surface temperature below 105°C during wave soldering.

### 4.Soldering General Notes

- 4.1.Through-hole LED digital displays are not suitable for reflow soldering.
- 4.2. If components will undergo multiple soldering processes or other high-heat treatments, please consult LuckyLight for compatibility.

### 5.Cleaning

- 5.1.Mild "no-clean" fluxes are recommended for soldering purposes.
- 5.2. If cleaning is necessary, LuckyLight suggests washing components with water only. Avoid using harsh organic solvents for cleaning as they can damage the plastic parts.

- 5.3. The cleaning process should occur at room temperature, and the devices should not be washed for more than one minute.
- 5.4. After using water in the cleaning process, promptly remove excess moisture from the component by utilizing forced-air drying.

## 6. Circuit Design Notes

- 6.1. Protective current-limiting resistors may be necessary to operate the LEDs within the specified range.
- 6.2. LEDs mounted in parallel should each be placed in series with its own current-limiting resistor.

Recommended Set-up

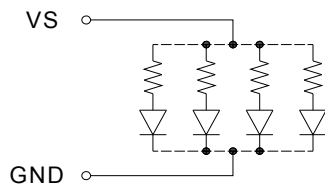

Invalid Set-up

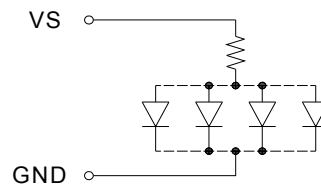

- 6.3. The driving circuit should be designed to protect the LED against reverse voltages and transient voltage spikes when the circuit is powered up or shut down.
- 6.4. The safe operating current should be selected by taking into account the maximum ambient temperature of the operating environment.
- 6.5. Extended reverse bias should be avoided as it may result in metal migration, leading to an escalation in leakage current or potential short circuits.

## 7. LED Storage Instructions

- 7.1. Store LEDs at or below 30°C and 80% relative humidity (RH) before opening the package.
- 7.2. LEDs should be used within one year of purchase.
- 7.3. After opening the package, store LEDs at or below 30°C and 60% RH.

## 8. ESD (Electrostatic Discharge)

Static Electricity or power surge will damage the LED. Suggestions to prevent ESD damage:

- 8.1. Use of a conductive wrist band or anti-electrostatic glove when handling these LEDs.
- 8.2. All devices, equipment, and machinery must be properly grounded.
- 8.3. Work tables, storage racks, etc. should be properly grounded.

## Disclaimer

### 1. Product Material and Specification Adjustment Rights:

LuckyLight reserves the right to update product materials or specifications to improve reliability, functionality, design, or for other valid reasons.

### 2. Description of Data in Datasheets:

The data presented in this datasheet represents typical values and does not constitute guaranteed figures. The data provided is for reference purposes only.

### 3. Compliance with Usage Instructions:

When using this product, please strictly adhere to the absolute maximum ratings and instructions outlined in the specification sheets. LuckyLight shall not be held responsible for any damage resulting from non-compliance with these instructions.

### 4. Application Limitations:

This product is not intended for applications in military, aviation, automotive, medical, life-sustaining, or life-saving fields where failure could cause personal injury or death. For specific application requirements, please consult an authorized LuckyLight sales representative.

### 5. Disclaimer:

LuckyLight strives for accuracy in its datasheets, specifications, and disclosures. However, we cannot be held liable for any errors or omissions. Product suitability for specific applications is the customer's responsibility.

### 6. Limitation of Liability:

LuckyLight's liability is limited to the cost of the product. We are not liable for any damages arising from product application, continued production, or any product usage.

# KA2-541ABB / KA2-541CBB



0.54-inch (13.80 mm) 2-Digit 14-Segment Alphanumeric Display

Blue Through-Hole Dual-Digit LED Alphanumeric Display

## Technical Data Sheet

---

### Revision History

Revision	Date	Contents	Page
Rev. 1	November 20, 2017	Original Version	/
Rev. 1.1	November 22, 2017	Product Images	1