

KW3-281CWB-P21H

0.28-inch(7 mm) White LED Display

Three Digit 7-segment LED Display

Technical Data Sheet

Features

- High reliability
- Low power consumption
- Excellent characters appearance
- Evenly lighted segments
- Wide viewing angle
- Easy mounting on PCB or sockets
- I.C. compatible
- RoHS compliant



Descriptions

- The KW3-281CWB-P21H is a 0.28-inch (7 mm) digit height seven-segment LED display.
- The display offers excellent visibility and reliability under bright ambient light conditions.
- The device features white diffused segments with a black surface.

Applications

- Home and smart appliances
- Instrument panels
- Display time and digital combination
- Test and measurement equipment
- Control units

Part No.	Emitting Color	Circuit Common
KW3-281CWB-P21H	White	Common Cathode

KW3-281CWB-P21H

0.28-inch(7 mm) White LED Display

Three Digit 7-segment LED Display

Technical Data Sheet

Package Dimension

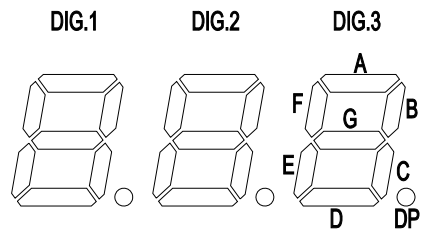
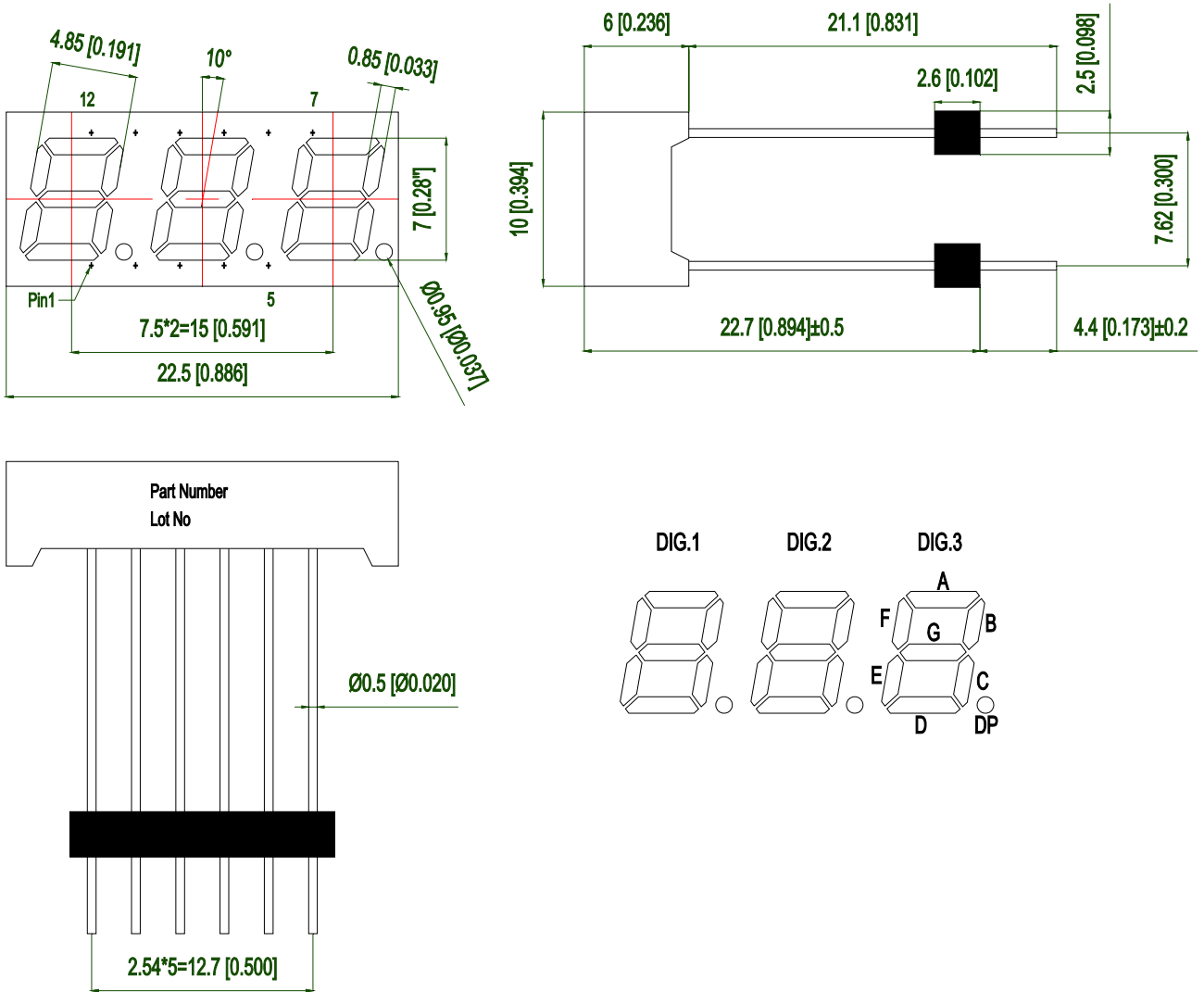

Notes:

1. All dimensions are in millimeters (inches).
2. Tolerance is ± 0.25mm (.010") unless otherwise noted.
3. The specifications, characteristics and technical data described in the datasheet are subject to change without prior notice.

KW3-281CWB-P21H

0.28-inch(7 mm) White LED Display

Three Digit 7-segment LED Display

Technical Data Sheet

Internal Circuit Diagram

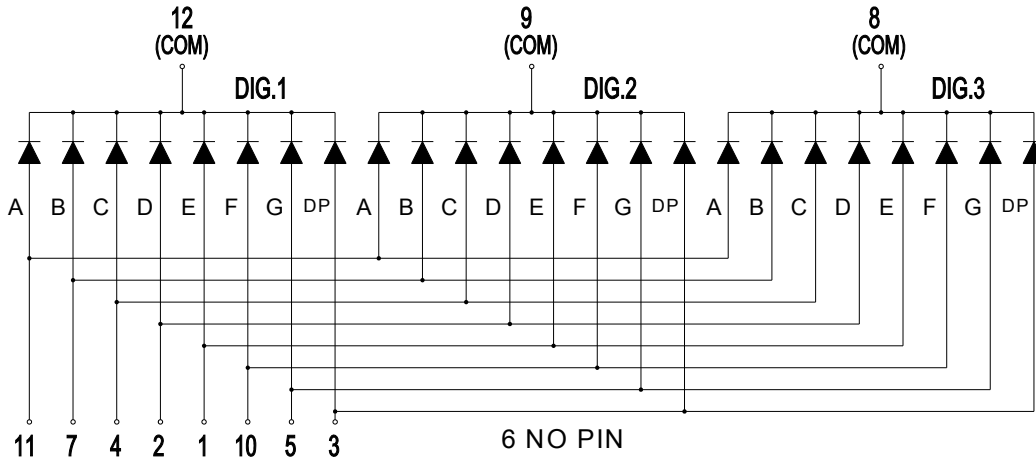

Recommended PCB Layout

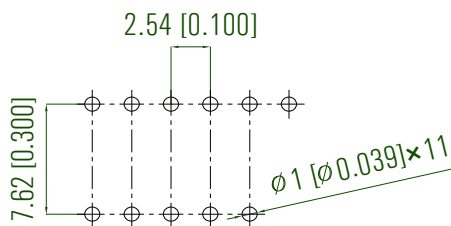

KW3-281CWB-P21H

0.28-inch(7 mm) White LED Display

Three Digit 7-segment LED Display

Technical Data Sheet

Absolute Maximum Ratings at $T_A=25^{\circ}\text{C}$

Parameters	Symbol	Max	Unit
Power Dissipation (Per Chip)	P_D	64	mW
Peak Forward Current (Per Segment) (1/10 Duty Cycle, 0.1ms Pulse Width)	I_{FP}	40	mA
Forward Current (Per Segment)	I_F	20	mA
Reverse Voltage (Per Chip)	V_R	5	V
Operating Temperature Range	T_{opr}	-40°C to +80°C	
Storage Temperature Range	T_{stg}	-40°C to +85°C	
Soldering Temperature	T_{sld}	260°C for 5 Seconds	

Electrical Optical Characteristics at $T_A=25^{\circ}\text{C}$

Parameters	Symbol	Min.	Typ.	Max.	Unit	Test Condition
Average Luminous Intensity	I_v	16.5	32.5	---	mcd	IF=5mA (Note a)
		32.5	65.0	---	mcd	IF=10mA (Note a)
Luminous Intensity Matching Ratio	I_{v-m}	---	---	2:1		IF=10mA
Chromaticity Coordinates	x	---	0.30	---		IF=20mA (Note b)
	y	---	0.31	---		
Spectral Line Half-Width	$\Delta\lambda$	---	20	---	nm	IF=20mA
Forward Voltage (Per Segment)	V_F	---	3.0	3.2	V	IF=20mA(Note c)
Reverse Current (Per Segment)	I_R	---	---	50	μA	VR=5V

Notes:

- Luminous intensity is measured with a light sensor and filter combination that approximates the CIE eye-response curve.
Tolerance of Luminous Intensity: $\pm 10\%$.
- The chromaticity coordinates (x, y) is derived from the 1931 CIE chromaticity diagram..
- Tolerance of Forward Voltage: $\pm 0.1\text{V}$.

KW3-281CWB-P21H

0.28-inch(7 mm) White LED Display

Three Digit 7-segment LED Display

Technical Data Sheet

Chromaticity Coordinates Specifications for Bin Rank

Color Bin at IF = 10mA

Bin Code	CIE 1931Chromaticity Coordinates				
		x	y	x	y
W1	x	0.284	0.278	0.304	0.298
	y	0.284	0.311	0.332	0.298
W2	x	0.304	0.268	0.324	0.292
	y	0.304	0.298	0.322	0.292
W3	x	0.304	0.298	0.324	0.322
	y	0.304	0.332	0.352	0.322

Tolerance on each Hue (x, y) bin is +/- 0.01.

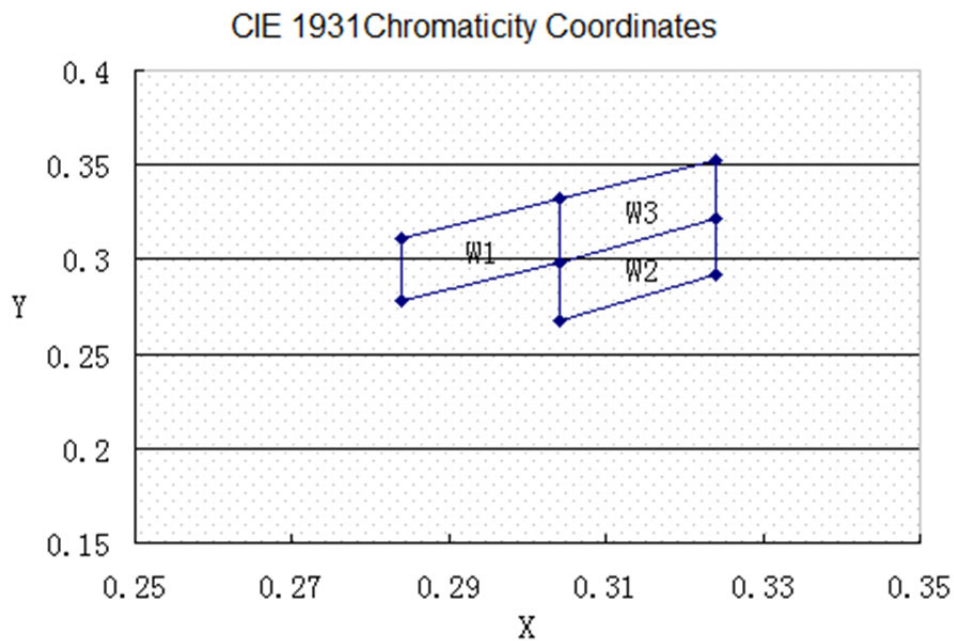

KW3-281CWB-P21H

0.28-inch(7 mm) White LED Display

Three Digit 7-segment LED Display

Technical Data Sheet

Typical Electrical/Optical Characteristic Curves at $T_A = 25^\circ\text{C}$

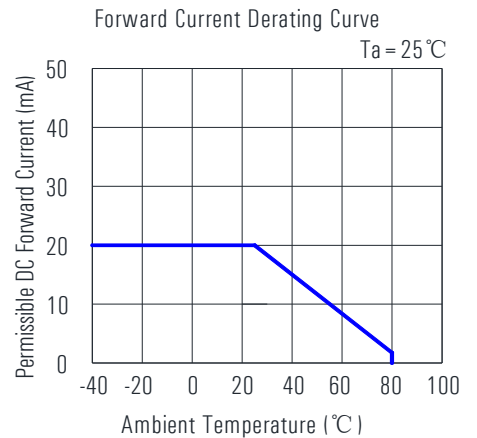
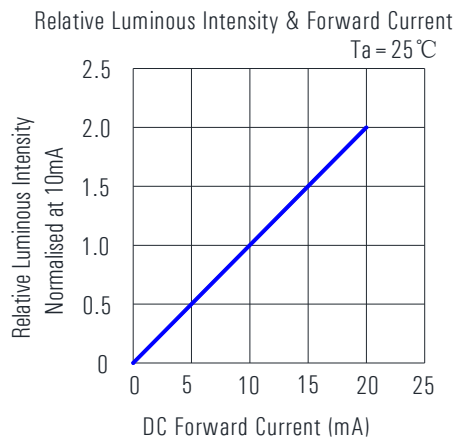
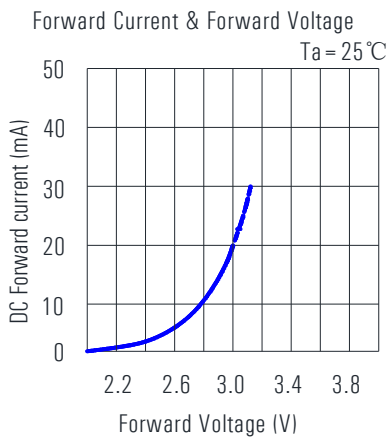
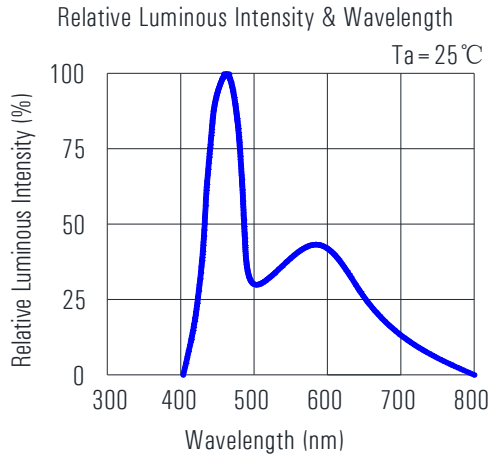

KW3-281CWB-P21H

0.28-inch(7 mm) White LED Display

Three Digit 7-segment LED Display

Technical Data Sheet

Packing & Label Specifications

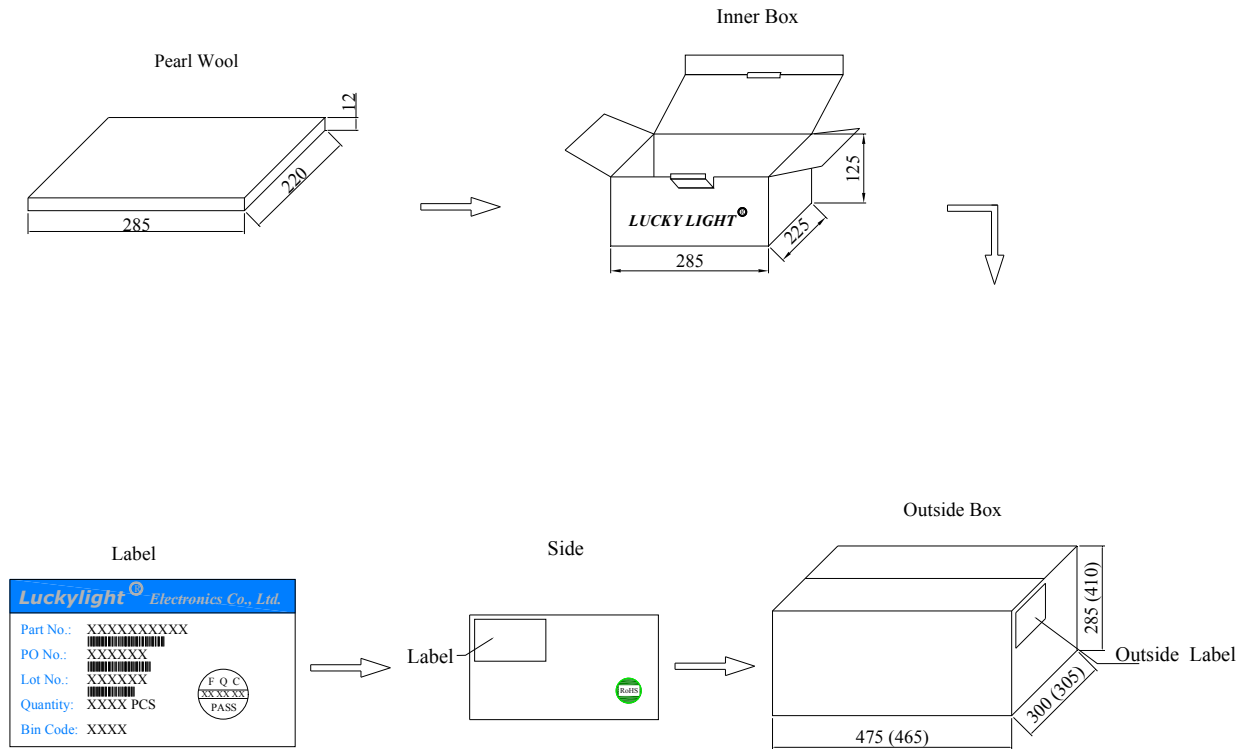

Notes:

1. The above "Packing & Label Specifications" refer to bag packaging and are for reference only.
2. Bag packaging will be used for through-hole LED digital displays with character heights exceeding 0.8 inches.
3. LuckyLight through-hole LED digital displays offer three packaging options: tube, bag, and box. If customers have special packaging requirements, please confirm the required packaging method with the salesperson in advance when placing an order.

KW3-281CWB-P21H

0.28-inch(7 mm) White LED Display

Three Digit 7-segment LED Display

Technical Data Sheet

Precautions

Through Hole Digital Display Mounting Method

1. Lead Forming

- 1.1. Do not bend the component leads by hand without proper tools.
- 1.2. The leads should be bent by clinching the upper part of the lead firmly so that the bending force is not exerted on the plastic body.

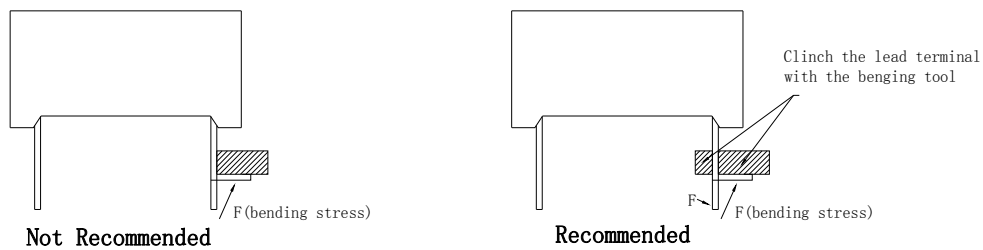

2. Installation

- 2.1. The installation process should not apply stress to the lead terminals.
- 2.2. When inserting for assembly, ensure the terminal pitch matches the substrate board's hole pitch to prevent spreading or pinching of the lead terminals.



- 2.3. The component shall be placed at least 5mm from the edge of the PCB to avoid damage caused by excessive heat during wave soldering.

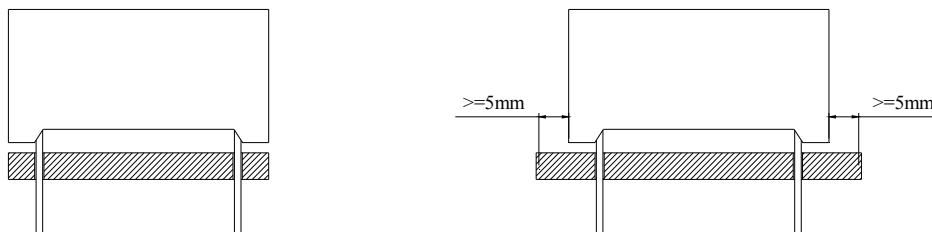

KW3-281CWB-P21H

0.28-inch(7 mm) White LED Display

Three Digit 7-segment LED Display

Technical Data Sheet

3.Recommended Wave Soldering Profiles

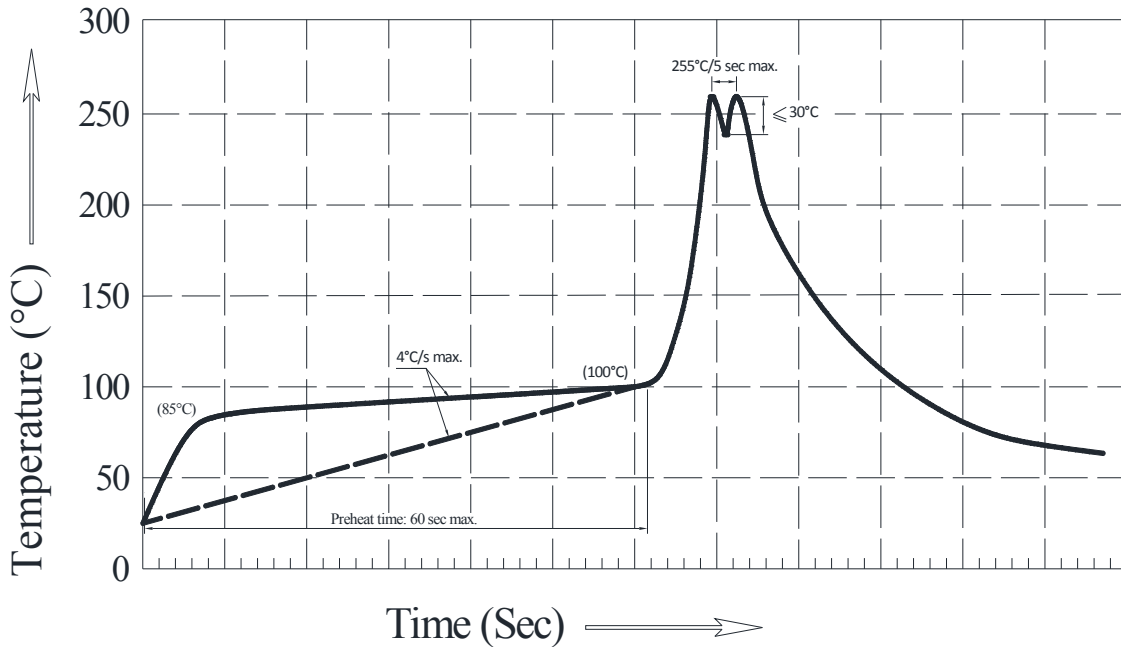

Notes:

- 3.1.It is recommended to pre-heat at a temperature of 105°C or lower (measured using a thermocouple attached to the LED pins) before immersion in the solder wave, with a maximum solder bath temperature of 260°C.
- 3.2. The peak wave soldering temperature should be between 245°C to 255°C for 3 seconds (maximum of 5 seconds).
- 3.3. Avoid applying stress to the epoxy resin when the temperature exceeds 85°C.
- 3.4.Fixtures should not exert stress on the component during mounting and soldering processes.
- 3.5. Only one wave soldering pass is allowed.
- 3.6.Maintain the PCB top-surface temperature below 105°C during wave soldering.

4.Soldering General Notes

- 4.1.Through-hole LED digital displays are not suitable for reflow soldering.
- 4.2. If components will undergo multiple soldering processes or other high-heat treatments, please consult LuckyLight for compatibility.

5.Cleaning

- 5.1.Mild "no-clean" fluxes are recommended for soldering purposes.
- 5.2. If cleaning is necessary, LuckyLight suggests washing components with water only. Avoid using harsh organic solvents for cleaning as they can damage the plastic parts.

KW3-281CWB-P21H

0.28-inch(7 mm) White LED Display

Three Digit 7-segment LED Display

Technical Data Sheet

- 5.3. The cleaning process should occur at room temperature, and the devices should not be washed for more than one minute.
- 5.4. After using water in the cleaning process, promptly remove excess moisture from the component by utilizing forced-air drying.

6.Circuit Design Notes

- 6.1. Protective current-limiting resistors may be necessary to operate the LEDs within the specified range.
- 6.2. LEDs mounted in parallel should each be placed in series with its own current-limiting resistor.

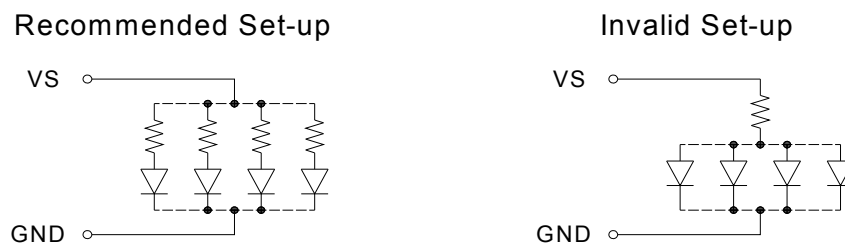

- 6.3. The driving circuit should be designed to protect the LED against reverse voltages and transient voltage spikes when the circuit is powered up or shut down.
- 6.4. The safe operating current should be selected by taking into account the maximum ambient temperature of the operating environment.
- 6.5. Extended reverse bias should be avoided as it may result in metal migration, leading to an escalation in leakage current or potential short circuits.

7.LED Storage Instructions

- 7.1. Store LEDs at or below 30°C and 80% relative humidity (RH) before opening the package.
- 7.2. LEDs should be used within one year of purchase.
- 7.3. After opening the package, store LEDs at or below 30°C and 60% RH.

8.ESD (Electrostatic Discharge)

Static Electricity or power surge will damage the LED. Suggestions to prevent ESD damage:

- 8.1. Use of a conductive wrist band or anti-electrostatic glove when handling these LEDs.
- 8.2. All devices, equipment, and machinery must be properly grounded.
- 8.3. Work tables, storage racks, etc. should be properly grounded.

KW3-281CWB-P21H**0.28-inch(7 mm) White LED Display****Three Digit 7-segment LED Display****Technical Data Sheet**

Disclaimer**1. Product Material and Specification Adjustment Rights:**

LuckyLight reserves the right to update product materials or specifications to improve reliability, functionality, design, or for other valid reasons.

2. Description of Data in Datasheets:

The data presented in this datasheet represents typical values and does not constitute guaranteed figures. The data provided is for reference purposes only.

3. Compliance with Usage Instructions:

When using this product, please strictly adhere to the absolute maximum ratings and instructions outlined in the specification sheets. LuckyLight shall not be held responsible for any damage resulting from non-compliance with these instructions.

4. Application Limitations:

This product is not intended for applications in military, aviation, automotive, medical, life-sustaining, or life-saving fields where failure could cause personal injury or death. For specific application requirements, please consult an authorized LuckyLight sales representative.

5. Disclaimer:

LuckyLight strives for accuracy in its datasheets, specifications, and disclosures. However, we cannot be held liable for any errors or omissions. Product suitability for specific applications is the customer's responsibility.

6. Limitation of Liability:

LuckyLight's liability is limited to the cost of the product. We are not liable for any damages arising from product application, continued production, or any product usage.

KW3-281CWB-P21H

0.28-inch(7 mm) White LED Display

Three Digit 7-segment LED Display

Technical Data Sheet

Revision History

Revision	Date	Contents	Page
Rev. 1	June 3, 2026	Original Version	/