

KW3-S561AAB/KW3-S561CAB

0.56 inch (14.20mm), Orange
Triple Digit 7-segment SMD LED Display

Technical Data Sheet

Features

- 0.56 inch (14.20mm) digit height.
- The thickness is thinner than traditional display.
- Packaged in tape and reel for SMT manufacturing.
- Low current operation.
- Excellent character appearance.
- Categorized for luminous intensity.
- Available in CA and CC.
- The product itself will remain within RoHS compliant Version.



Descriptions

- The KW3-S561AAB/ KW3-S561CAB is a 0.56 inch (14.20mm) height triple digit display.
- The display provides excellent reliability in bright ambient light.
- The device is made with white segments and black surface.

Applications

- Home appliances
- Game machine
- Instrument panels
- Digital readout displays

Device Selection Guide

Part No.	Emitting Color	Polarity
KW3-S561AAB	Orange	Common Anode
KW3-S561CAB	Orange	Common Cathode

0.56 inch (14.20mm), Orange
 Triple Digit 7-segment SMD LED Display

Technical Data Sheet

Package Dimension

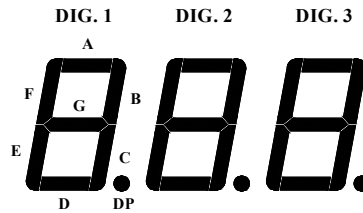
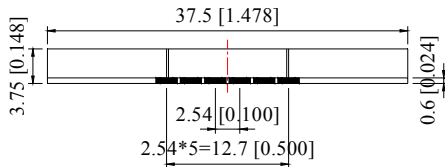
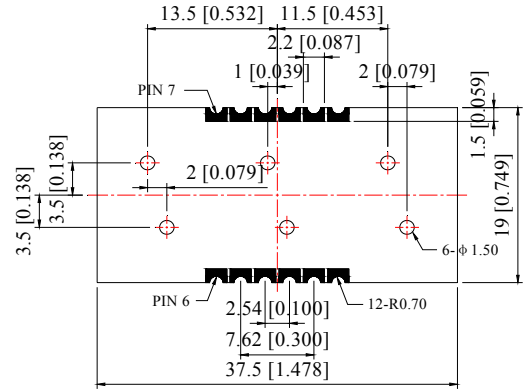
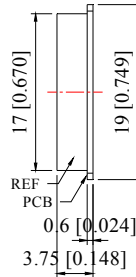
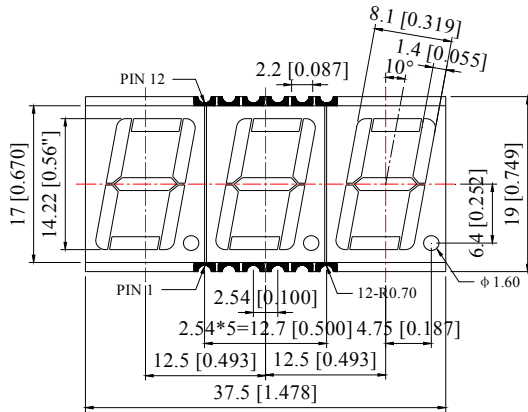

Notes:

1. All dimensions are in millimeters (inches).
2. Tolerance is ± 0.25 mm (.010") unless otherwise noted.
3. The gap between the reflector and PCB shall not exceed 0.25mm.

KW3-S561AAB/KW3-S561CAB



0.56 inch (14.20mm), Orange
Triple Digit 7-segment SMD LED Display

Technical Data Sheet

Internal Circuit Diagram:

Internal Circuit Diagram (Common Anode)

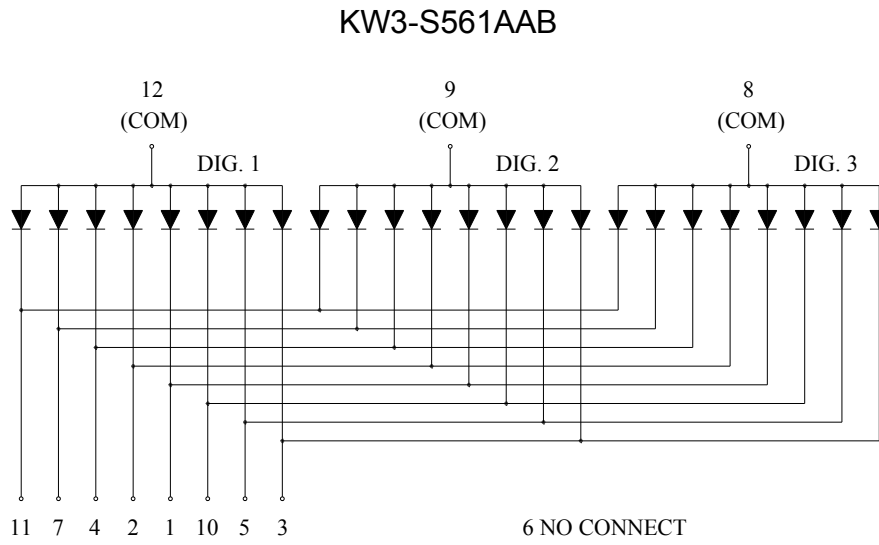

Internal Circuit Diagram (Common Cathode)

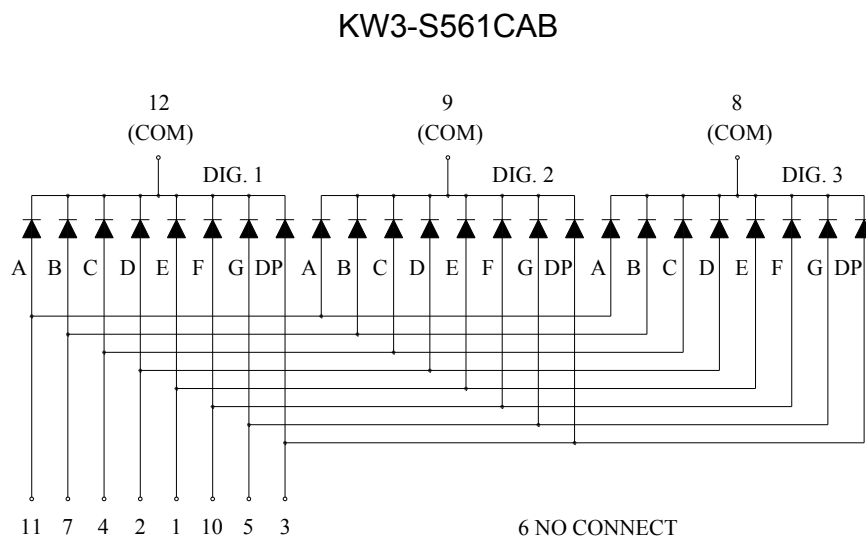

0.56 inch (14.20mm), Orange

Triple Digit 7-segment SMD LED Display

Technical Data Sheet

Absolute Maximum Ratings at Ta=25°C

Parameters	Symbol	Max	Unit
Power Dissipation Per Segment	P_d	48	mW
Peak Forward Current Per Segment (1/10 Duty Cycle, 0.1ms Pulse Width)	I_{FP}	100	mA
Forward Current Per Segment	I_F	20	mA
Reverse Voltage Per Segment	V_R	5	V
Operating Temperature Range	T_{opr}	-40°C to +100°C	
Storage Temperature Range	T_{stg}	-40°C to +105°C	
Soldering Temperature	T_{sld}	260°C for 5 Seconds	

Electrical Optical Characteristics at Ta=25°C

Parameters	Symbol	Min.	Typ.	Max.	Unit	Test Condition
Average Luminous Intensity	I_v	14.0	28.0	---	mcd	IF=10mA (Note a)
Luminous Intensity Matching Ratio	I_{v-m}	---	---	2:1		IF=10mA
Peak Emission Wavelength	λ_p	---	610	---	nm	IF=20mA
Dominant Wavelength	λ_d	---	605	---	nm	IF=20mA (Note b)
Spectral Line Half-Width	$\Delta\lambda$	---	20	---	nm	IF=20mA
Forward Voltage Per Segment	V_F	---	2.1	2.4	V	IF=20mA
Reverse Current Per Segment	I_R	---	---	50	μ A	VR=5V

Notes:

- Luminous intensity is measured with a light sensor and filter combination that approximates the CIE eye-response curve.
- The dominant wavelength (λ_d) is derived from the CIE chromaticity diagram and represents the single wavelength which defines the color of the device.

0.56 inch (14.20mm), Orange

Triple Digit 7-segment SMD LED Display

Technical Data Sheet

**Typical Electrical / Optical Characteristics Curves
(25°C Ambient Temperature Unless Otherwise Noted)**

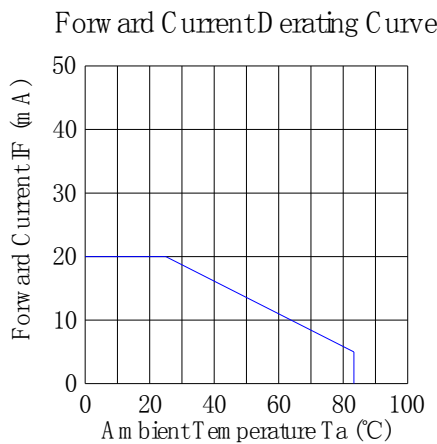
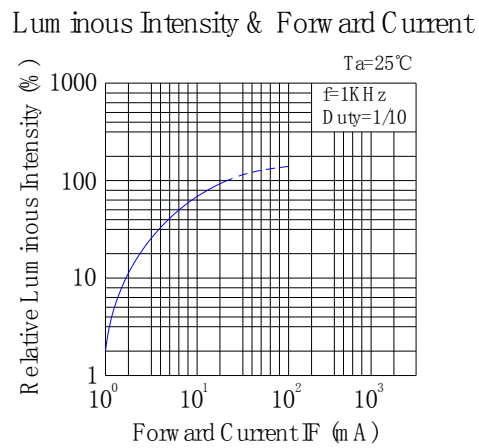
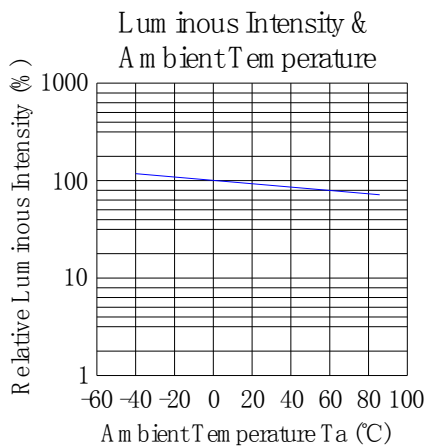
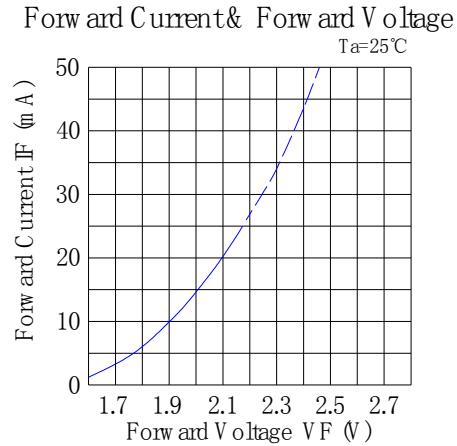
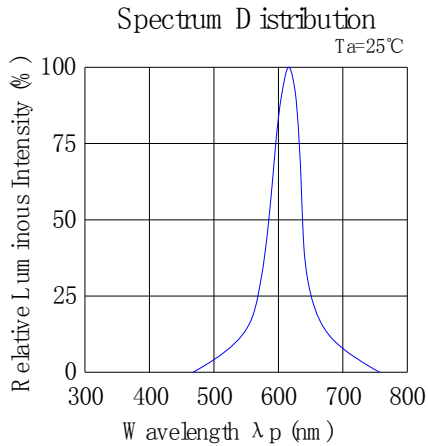

KW3-S561AAB/KW3-S561CAB



0.56 inch (14.20mm), Orange
Triple Digit 7-segment SMD LED Display

Technical Data Sheet

The Products In The Reel Of Direction

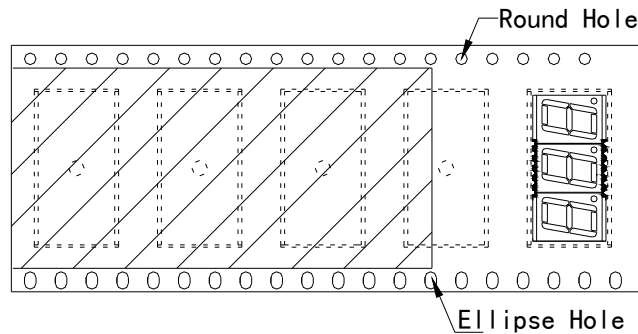

Label Direction & Content In The Roll

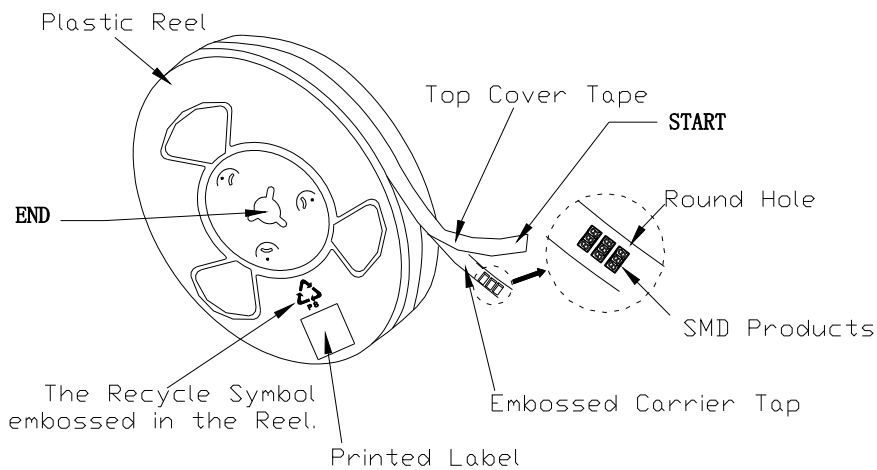

User Feed Direction

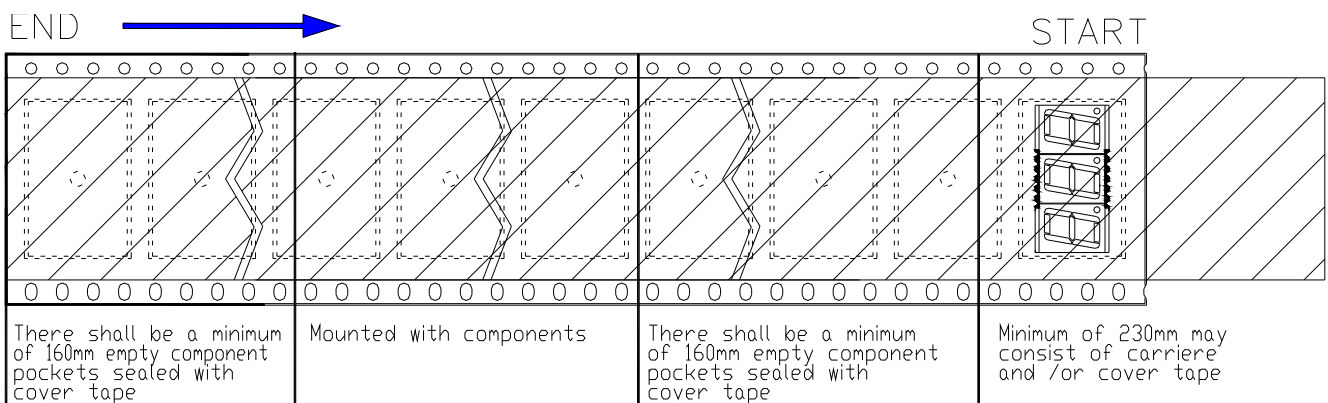

Package Criteria

1. Total unit per reel is 500PCS.
2. Max 5 reels/2500PCS are packaged in each carton.

0.56 inch (14.20mm), Orange

Triple Digit 7-segment SMD LED Display

Technical Data Sheet

Terms and conditions for the usage of this document

1. The information included in this document reflects representative usage scenarios and is intended for technical reference only.
2. The part number, type, and specifications mentioned in this document are subject to future change and improvement without notice. Before production usage customer should refer to the latest datasheet for the updated specifications.
3. When using the products referenced in this document, please make sure the product is being operated within the environmental and electrical limits specified in the datasheet. If customer usage exceeds the specified limits, LuckyLight will not be responsible for any subsequent issues.
4. The information in this document applies to typical usage in consumer electronics applications. If customer's application has special reliability requirements or have life-threatening liabilities, such as automotive or medical usage, please consult with LuckyLight representative for further assistance.
5. The contents and information of this document may not be reproduced or re-transmitted without permission by LuckyLight.
6. The LEDs should be operated with forward bias. The driving circuit must be designed so that the LEDs are not subjected to forward or reverse voltage while it is off. If reverse voltage is continuously applied to the LEDs, it may cause migration resulting in LED damage.

0.56 inch (14.20mm), Orange
 Triple Digit 7-segment SMD LED Display

Technical Data Sheet

Precautions for Use

1. Caution in ESD

Static electricity and surge damages the LED. It is recommended to use a wrist band or anti-electrostatic glove when handling the LED. All devices equipment and machinery must be properly grounded.

2. SMT Soldering Condition

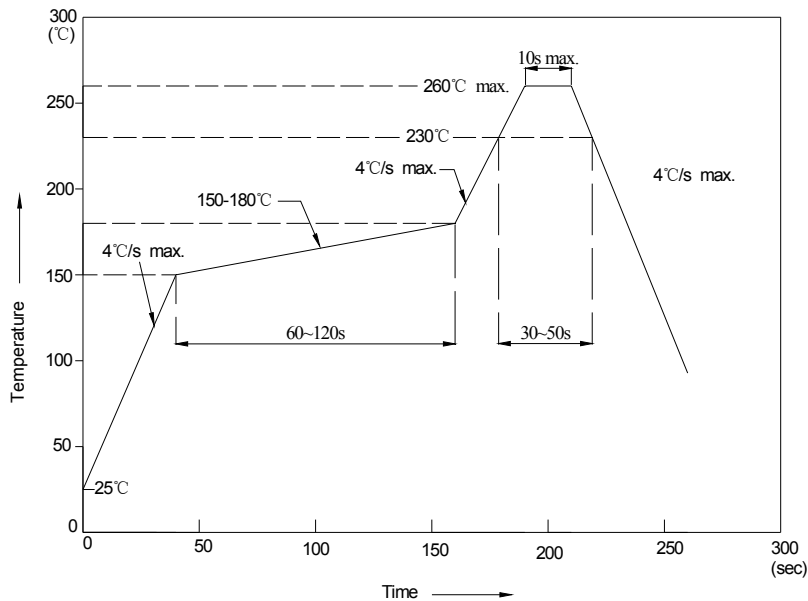

Reflow Soldering (Two times only)		Soldering Iron (One time only)	
Pre-heat	120~150°C	Temperature	300°C Max.
Pre-heat time	120 sec. Max.	Soldering time	3 sec. Max.
Peak temperature	260°C Max.		
Soldering time	5 sec. Max.		

3. Circuit Design Notes:

1. Protective current-limiting resistors may be necessary to operate the LEDs within the specified range.
2. LEDs mounted in parallel should each be placed in series with its own current-limiting resistor.

