

KWA-801AWA/KWA-801CWA

0.80 inch (20.32 mm) ,White

Single Digit 16-segment Alphanumeric LED Display

Technical Data Sheet

Features:

- 0.80" (inch) digit height
- Low current operation
- Excellent characters appearance
- Available in CA and CC
- RoHS Compliant

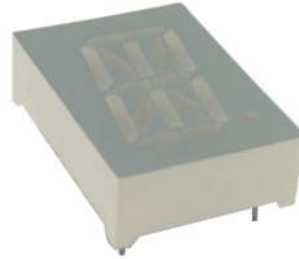

Descriptions:

- The KWA-801AWA/KWA-801CWA is a 0.80 inch (20.32mm) height Single digit Alphanumeric display.
- The display provides excellent reliability in bright ambient light.
- The device is made with white segments and gray surface.

Applications:

- Home appliances
- Instrument panels
- Digital readout displays

Device Selection Guide:

Part No.	Emitting Color	Polarity
KWA-801AWA	White	Common Anode
KWA-801CWA	White	Common Cathode

KWA-801AWA/KWA-801CWA



0.80 inch (20.32 mm) ,White

Single Digit 16-segment Alphanumeric LED Display

Technical Data Sheet

Package Dimension:

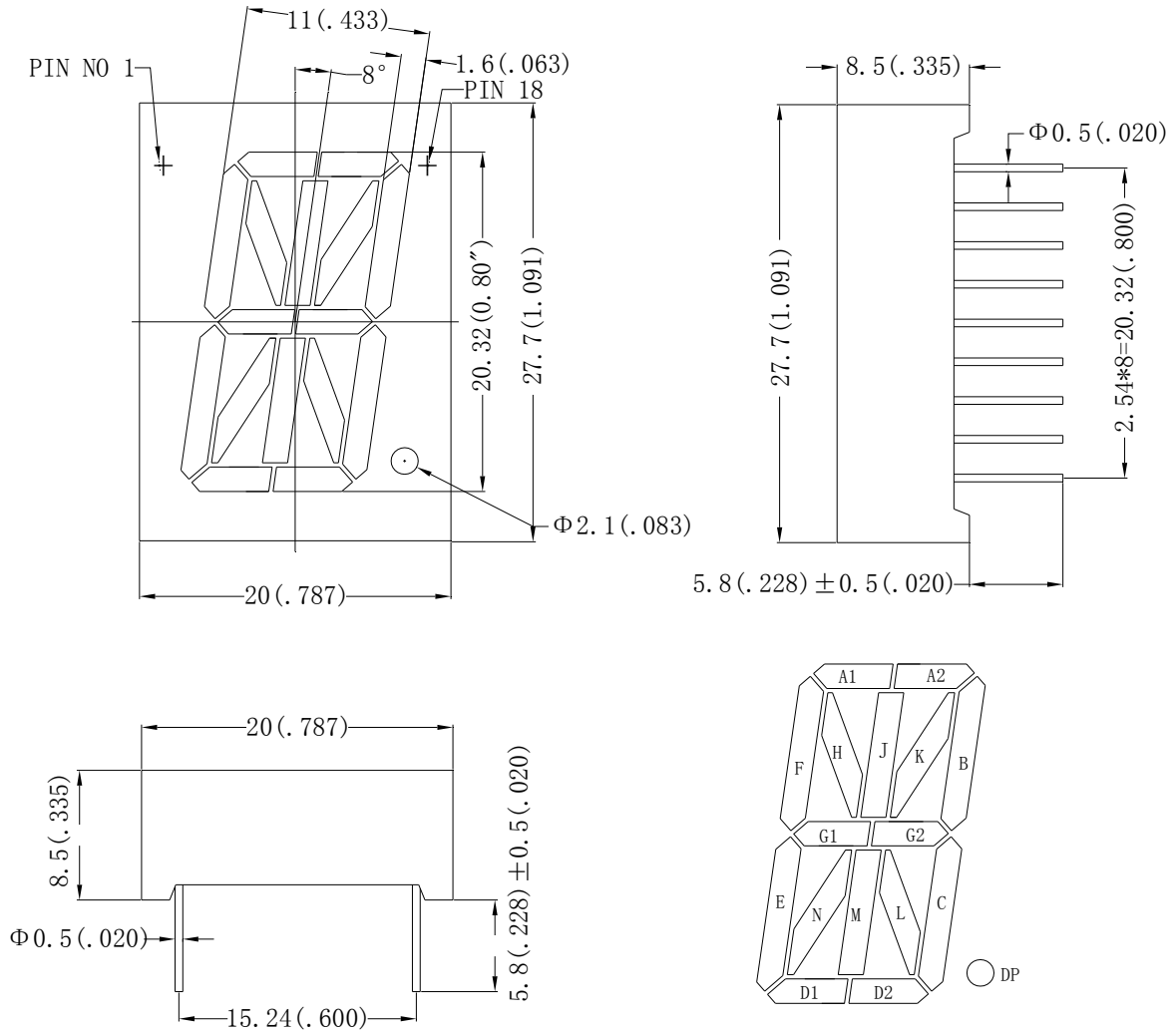

Notes:

1. All dimensions are in millimeters (inches).
2. Tolerance is ± 0.25 mm (.010") unless otherwise noted.

Spec No.: C8103AB

Issue No.: G-001-Rev-3

LuckyLight Electronics Co., Ltd

Copyright © 2017 LuckyLight All Rights Reserved

Date: 16-Mar-2017

E-mail: sales@luckylight.cn

http:// www.luckylight.cn

Page: 2 / 11

KWA-801AWA/KWA-801CWA

0.80 inch (20.32 mm) ,White

Single Digit 16-segment Alphanumeric LED Display



Technical Data Sheet

Internal Circuit Diagram:

Internal Circuit Diagram (Common Anode)

KWA-801AWA

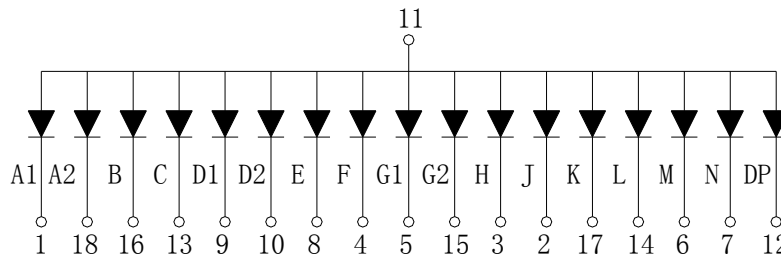

Internal Circuit Diagram (Common Cathode)

KWA-801CWA

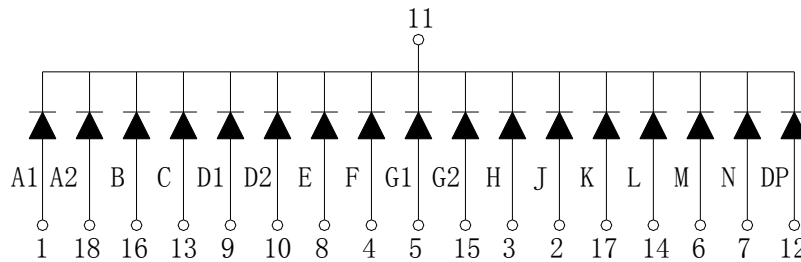

KWA-801AWA/KWA-801CWA

0.80 inch (20.32 mm) ,White

Single Digit 16-segment Alphanumeric LED Display



Technical Data Sheet

Absolute Maximum Ratings at Ta=25°C

Parameters	Symbol	Max	Unit
Power Dissipation Per Segment	P_d	35	mW
Peak Forward Current Per Segment (1/10 Duty Cycle, 0.1ms Pulse Width)	I_{FP}	50	mA
Forward Current Per Segment	I_F	10	mA
Reverse Voltage Per Segment	V_R	5	V
Operating Temperature Range	T_{opr}	-40°C to +80°C	
Storage Temperature Range	T_{stg}	-40°C to +85°C	
Soldering Temperature	T_{sld}	260°C for 5 Seconds	

Electrical Optical Characteristics at Ta=25°C

Parameters	Symbol	Min.	Typ.	Max.	Unit	Test Condition
Average Luminous Intensity	I_v	65	130	---	mcd	$I_F=10\text{mA}$ (Note 1, 2)
Luminous Intensity Matching Ratio	I_{v-m}	---	---	2:1		$I_F=10\text{mA}$
Chromaticity Coordinates	x	---	0.30	---		$I_F=10\text{mA}$ (Note 3)
	y	---	0.31	---		
Forward Voltage Per Segment	V_F	---	2.9	3.10	V	$I_F=10\text{mA}$
Reverse Current Per Segment	I_R	---	---	50	μA	$V_R=5\text{V}$

Notes:

- Luminous Intensity is a average value which is measured one 7-segment. Tolerance of Luminous Intensity: $\pm 10\%$.
- Excess driving current and / or operating temperature higher than recommended conditions may result in severe light degradation or premature failure.
- The chromaticity coordinates (x, y) is derived from the 1931 CIE chromaticity diagram.

KWA-801AWA/KWA-801CWA



0.80 inch (20.32 mm) ,White

Single Digit 16-segment Alphanumeric LED Display

Technical Data Sheet

Typical Electrical / Optical Characteristics Curves (25°C Ambient Temperature Unless Otherwise Noted)

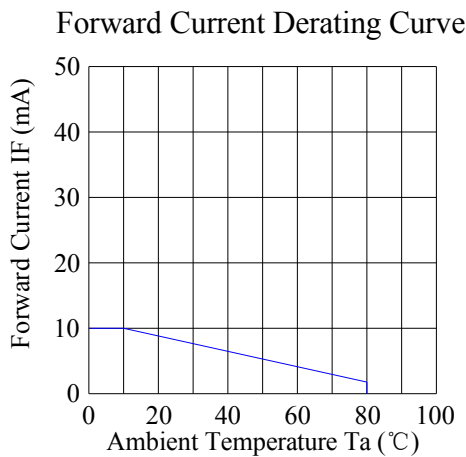
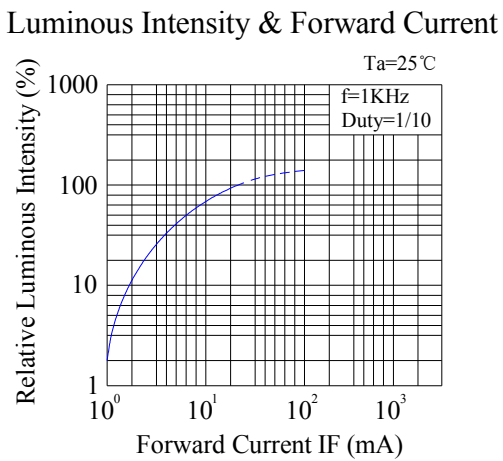
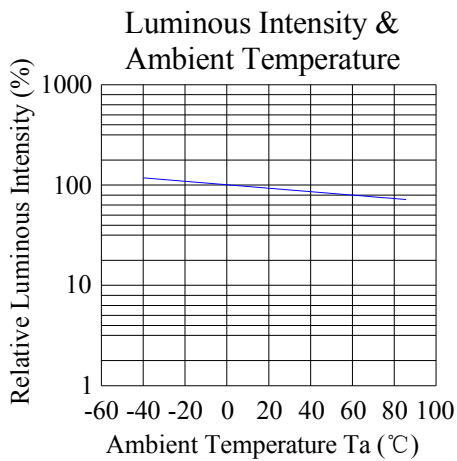
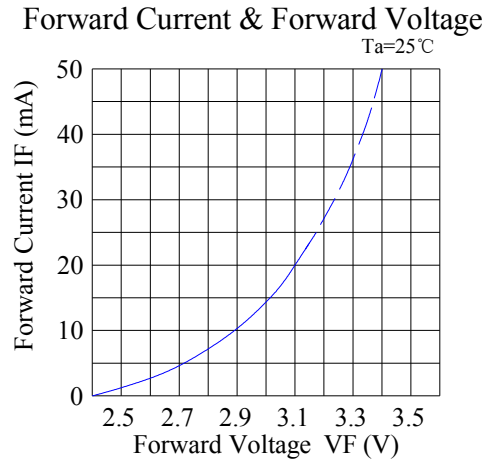
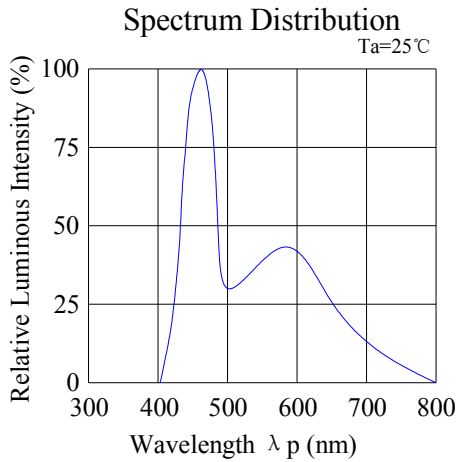

KWA-801AWA/KWA-801CWA

0.80 inch (20.32 mm) ,White

Single Digit 16-segment Alphanumeric LED Display



Technical Data Sheet

Chromaticity Coordinates Specifications for Bin Rank

Color Bin at IF = 10mA

Bin Code	CIE 1931 Chromaticity Coordinates				
		x	y	x	y
W1	x	0.284	0.278	0.304	0.298
	y	0.284	0.311	0.332	0.298
W2	x	0.304	0.268	0.324	0.292
	y	0.304	0.298	0.322	0.292
W3	x	0.304	0.298	0.324	0.322
	y	0.304	0.332	0.352	0.322

Tolerance on each Hue (x, y) bin is +/- 0.01.

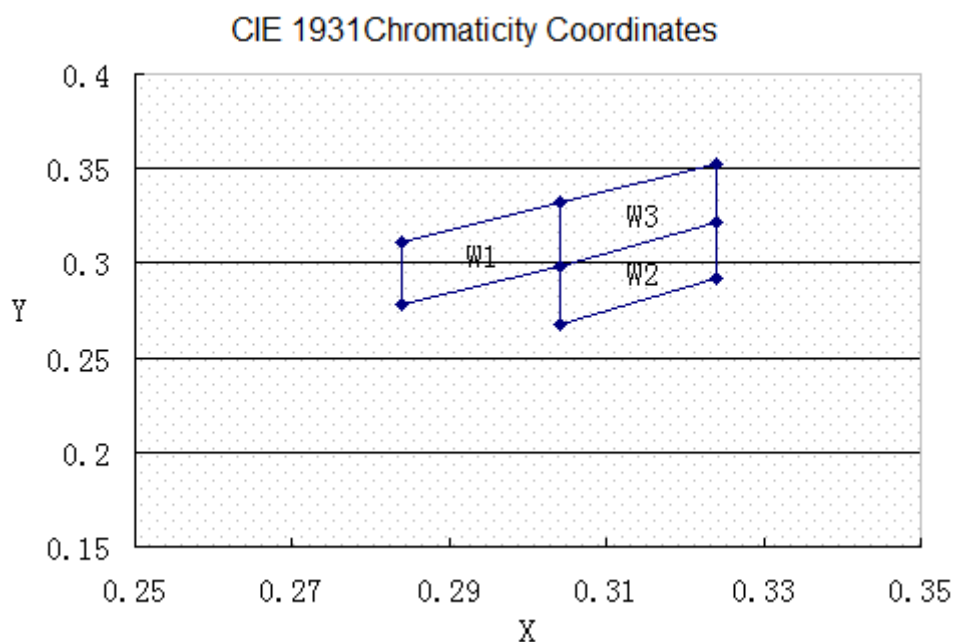

KWA-801AWA/KWA-801CWA



0.80 inch (20.32 mm) ,White

Single Digit 16-segment Alphanumeric LED Display

Technical Data Sheet

Packing & Label Specifications:

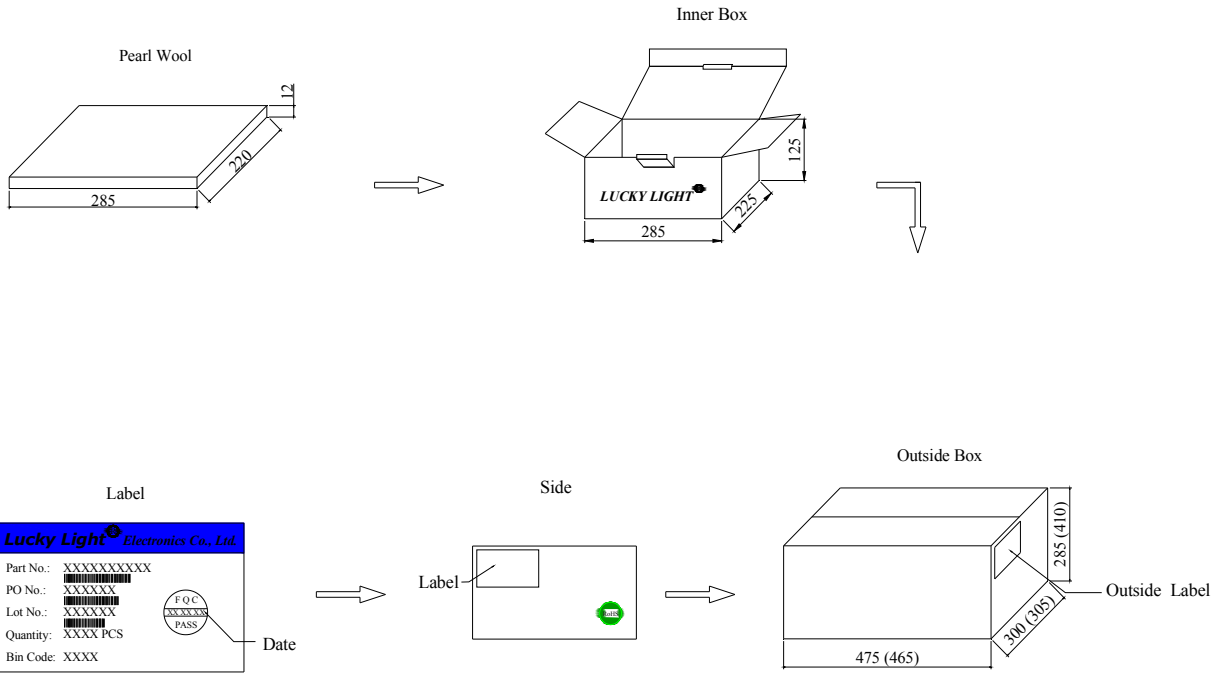

KWA-801AWA/KWA-801CWA

0.80 inch (20.32 mm) ,White

Single Digit 16-segment Alphanumeric LED Display



Technical Data Sheet

Terms and conditions for the usage of this document:

- a. The information included in this document reflects representative usage scenarios and is intended for technical reference only.
- b. The part number, type, and specifications mentioned in this document are subject to future change and improvement without notice. Before production usage customer should refer to the latest datasheet for the updated specifications.
- c. When using the products referenced in this document, please make sure the product is being operated within the environmental and electrical limits specified in the datasheet. If customer usage exceeds the specified limits, LuckyLight will not be responsible for any subsequent issues.
- d. The information in this document applies to typical usage in consumer electronics applications. If customer's application has special reliability requirements or have life-threatening liabilities, such as automotive or medical usage, please consult with LuckyLight representative for further assistance.
- e. The contents and information of this document may not be reproduced or re-transmitted without permission by LuckyLight.
- f. Over-current-proof
Customer must apply resistors for protection, otherwise slight voltage shift will cause big current change (Burn out will happen).

g. Storage

1. Before opening the package, the LEDs should be kept at 30°C or less and 80%RH or less.
2. The LEDs should be used within a year.
3. After opening the package, the LEDs should be kept at 30°C or less and 60%RH or less.

h. ESD (Electrostatic Discharge)

Static Electricity or power surge will damage the LED. Suggestions to prevent ESD damage:

Use of a conductive wrist band or anti-electrostatic glove when handling these LEDs.

All devices, equipment, and machinery must be properly grounded.

Work tables, storage racks, etc. should be properly grounded.

Technical Data Sheet**Through Hole Display Mounting Method****Lead Forming:**

1. Do not bend the component leads by hand without proper tools.
2. The leads should be bent by clinching the upper part of the lead firmly such that the bending force is not exerted on the plastic body.

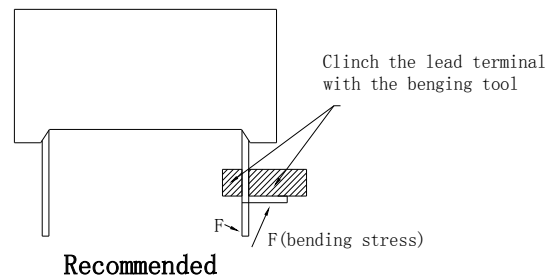
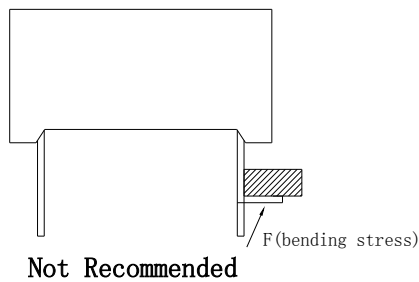
**Installation:**

1. The installation process should not apply stress to the lead terminals.
2. When inserting for assembly, ensure the terminal pitch matches the substrate board's hole pitch to prevent spreading or pinching the lead terminals.

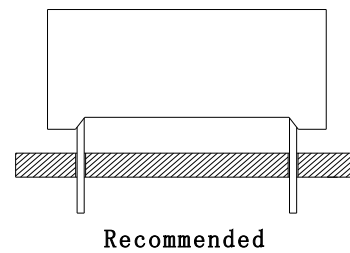
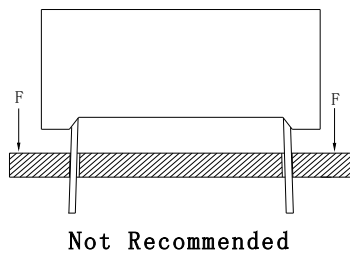

3. The component shall be placed at least 5mm from edge of PCB to avoid damage caused excessive heat during wave soldering.

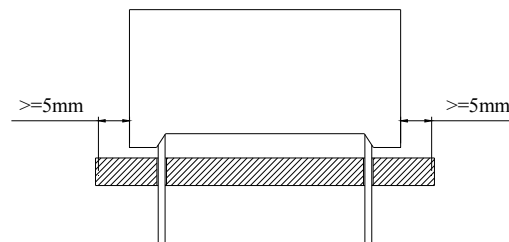
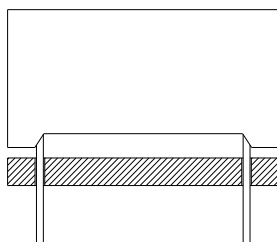

KWA-801AWA/KWA-801CWA

0.80 inch (20.32 mm) ,White

Single Digit 16-segment Alphanumeric LED Display

LuckyLight

Technical Data Sheet

Recommended Wave Soldering Profiles

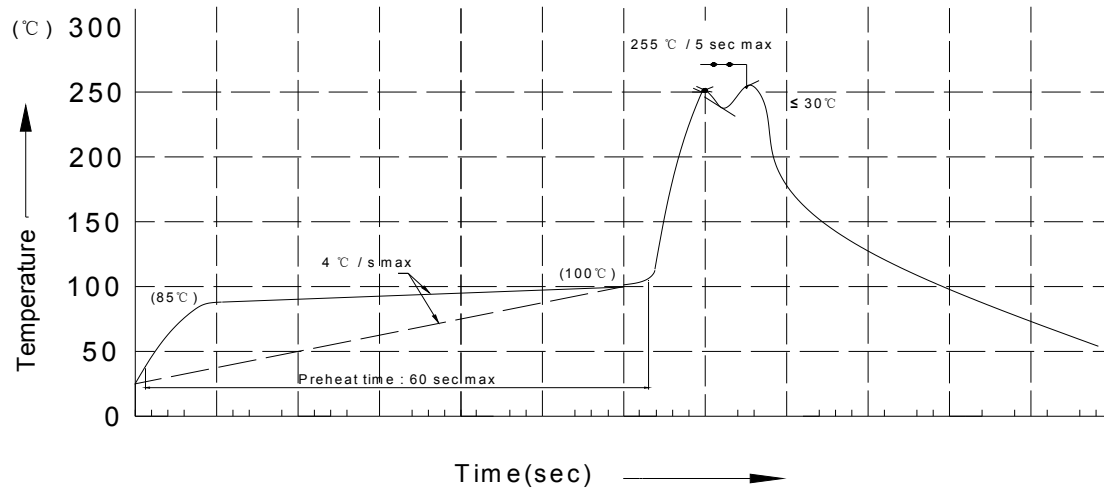

Notes:

1. Recommend pre-heat temperature of 105°C or less (as measured with a thermocouple attached to the LED pins) prior to immersion in the solder wave with a maximum solder bath temperature of 260°C.
2. Peak wave soldering temperature between 245°C~255°C for 3 sec (5 sec max).
3. Do not apply stress to the epoxy resin while the temperature is above 85°C.
4. Fixtures should not incur stress on the component when mounting and during soldering process.
5. SAC 305 solder alloy is recommended.
6. No more than one wave soldering pass.
7. During wave soldering, the PCB top-surface temperature should be kept below 105°C.

Soldering General Notes:

1. Through-hole displays are incompatible with reflow soldering.
2. If components will undergo multiple soldering processes, or other processes where the components may be subjected to intense heat, please check with luckyLight for compatibility.

Technical Data Sheet

Cleaning:

1. Mild “no-clean” fluxes are recommended for use in soldering.
2. If cleaning is required, luckylight recommends to wash components with water only.
Do not use harsh organic solvents for cleaning because they may damage the plastic parts.
3. The cleaning process should take place at room temperature and the devices should not be washed for more than one minute.
4. When water is used in the cleaning process, immediately remove excess moisture from the component with forced-air drying afterwards.

Circuit Design Notes:

1. Protective current-limiting resistors may be necessary to operate the LEDs within the specified range.
2. LEDs mounted in parallel should each be placed in series with its own current-limiting resistor.

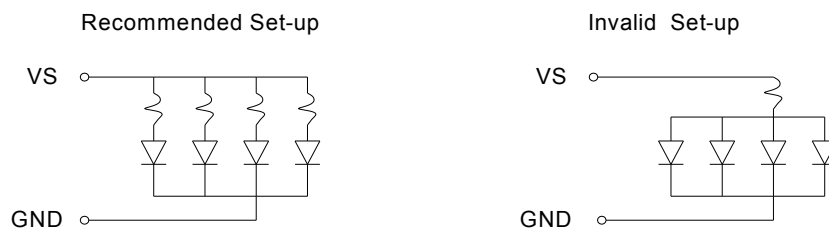

3. The driving circuit should be designed to protect the LED against reverse voltages and transient voltage spikes when the circuit is powered up or shut down.
4. The safe operating current should be chosen after considering the maximum ambient temperature of the operating environment.
5. Prolonged reverse bias should be avoided, as it could cause metal migration, leading to an increase in leakage current or causing a short circuit.