

KWB-R8445-1PG-L245-CT

84.00mm×45.00mm ,Pure Green

LCD Backlight

LuckyLight

Technical Data Sheet

Features:

- Low current operation
- Excellent characters appearance
- Large area, uniform, bright light emitting surface.
- RoHS Compliant



Descriptions:

- The KWB-R8445-1PG-L245-CT is used as a backlight of emitting area 84.00mm×45.00mm.
- The display provides excellent reliability in bright ambient light.

Applications:

- Flat backlight for LCD, switches and symbols.
- Indicator and backlight in office equipment.
- Indicator and backlight for battery driven equipment.
- Indicator and backlight for audio and video equipment.
- Automotive: Backlighting in dashboards and switches.
- Telecommunication: Indicator and backlighting in telephone and fax.

Device Selection Guide:

Part No.	Emitting Color	Face Color
KWB-R8445-1PG-L245-CT	Pure Green	White

KWB-R8445-1PG-L245-CT

84.00mm×45.00mm ,Pure Green

LCD Backlight

Technical Data Sheet

Package Dimension:

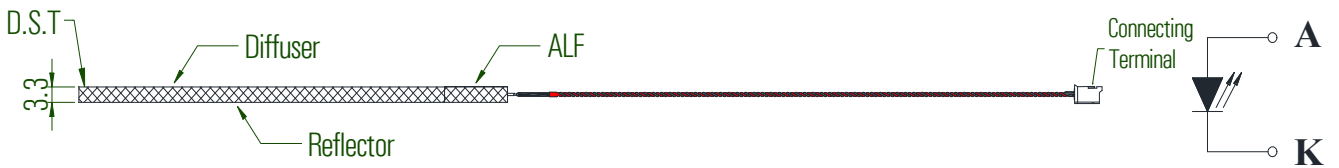
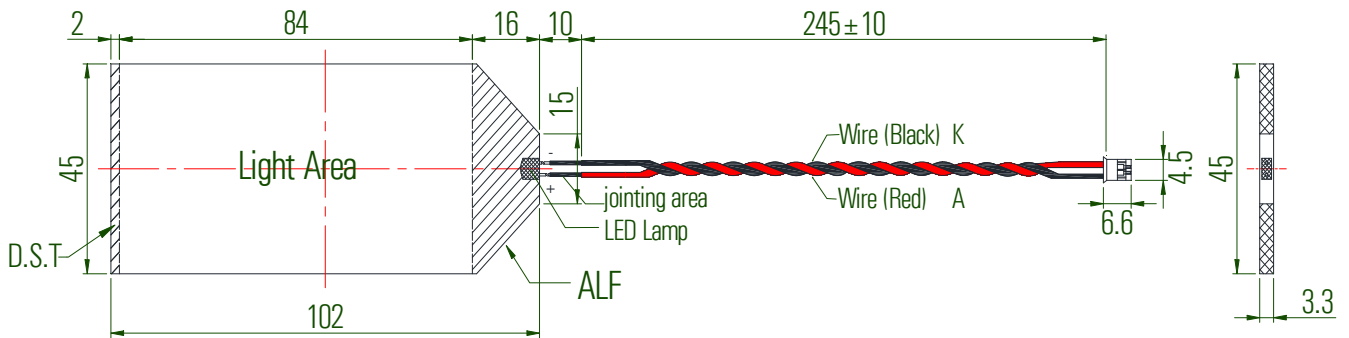

- ALF (Aluminium Foil)
- D.S.T. (Double Side Tape)
- E.L.A. (Effective Light Area)

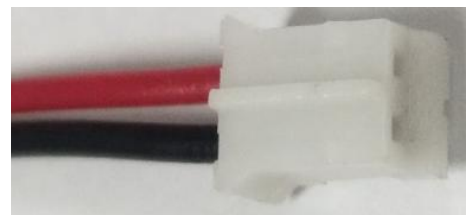
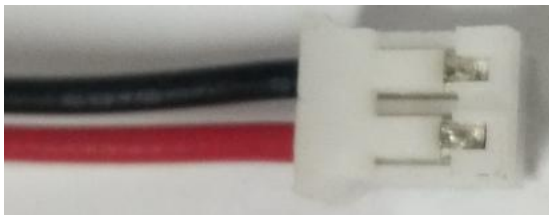

Notes:

- All dimensions are in millimeters (inches).
- Tolerance is ± 0.25 mm (.010") unless otherwise noted.

Spec No.: R8445

Issue No.: G-001-Rev-3

LuckyLight Electronics Co., Ltd

Copyright © 2017 LuckyLight All Rights Reserved

Date: 16-Mar-2017

E-mail: sales@luckylight.cn

http:// www.luckylight.cn

Page: 2 / 9

KWB-R8445-1PG-L245-CT

84.00mm×45.00mm ,Pure Green

LCD Backlight

Luckylight

Technical Data Sheet

Absolute Maximum Ratings at Ta=25°C

Parameters	Symbol	Max	Unit
Power Dissipation	P_d	65	mW
Peak Forward Current (1/10 Duty Cycle, 0.1ms Pulse Width)	I_{FP}	25	mA
Forward Current	I_F	20	mA
Reverse Voltage	V_R	5	V
Operating Temperature Range	T_{opr}	-20°C to +70°C	
Storage Temperature Range	T_{stg}	-25°C to +75°C	
Soldering Temperature	T_{slid}	260°C for 5 Seconds	

Electrical Optical Characteristics at Ta=25°C

Parameters	Symbol	Min.	Typ.	Max.	Unit	Test Condition
Average Luminous Intensity	I_v	50	100	---	cd/m ²	IF=10mA (Note a)
Luminous Uniformity		---	75%	---		IF=20mA
Peak Emission Wavelength	λ_p	---	520	---	nm	IF=20mA
Dominant Wavelength	λ_d	---	525	---	nm	IF=20mA (Note b)
Spectral Line Half-Width	$\Delta\lambda$	---	20	---	nm	IF=20mA
Forward Voltage	V_F	---	2.90	3.10	V	IF=20mA
Reverse Current	I_R	---	---	50	μA	VR=5V

Notes:

- Luminous intensity is measured with a light sensor and filter combination that approximates the CIE eye-response curve.
- The dominant wavelength (λ_d) is derived from the CIE chromaticity diagram and represents the single wavelength which defines the color of the device.

Technical Data Sheet

**Typical Electrical / Optical Characteristics Curves
(25°C Ambient Temperature Unless Otherwise Noted)**

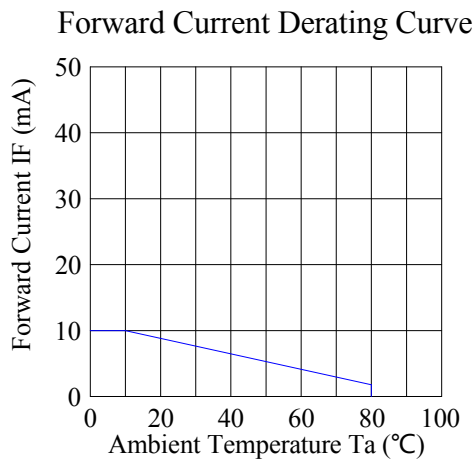
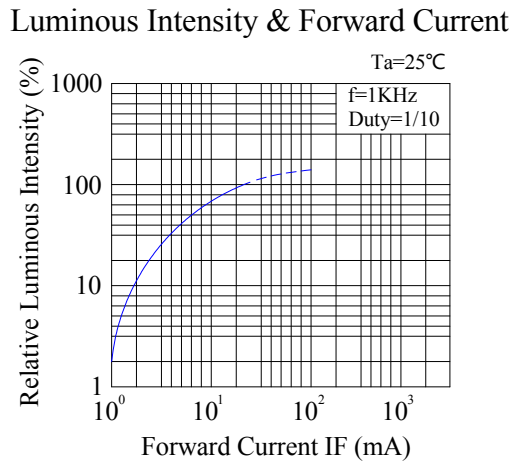
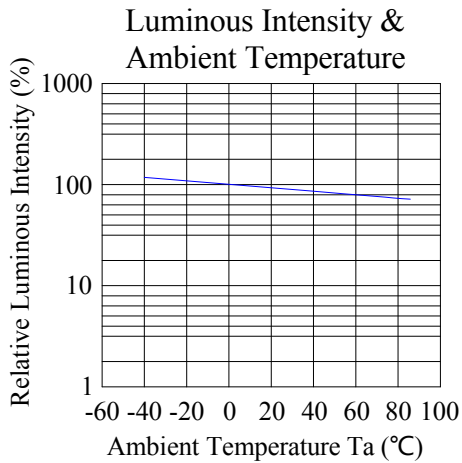
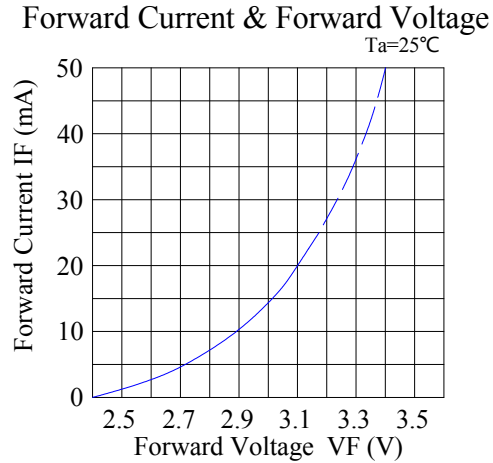
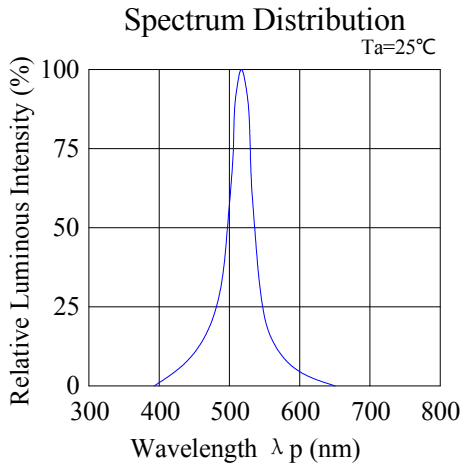

KWB-R8445-1PG-L245-CT

84.00mm×45.00mm ,Pure Green

LCD Backlight



Technical Data Sheet

Packing & Label Specifications:

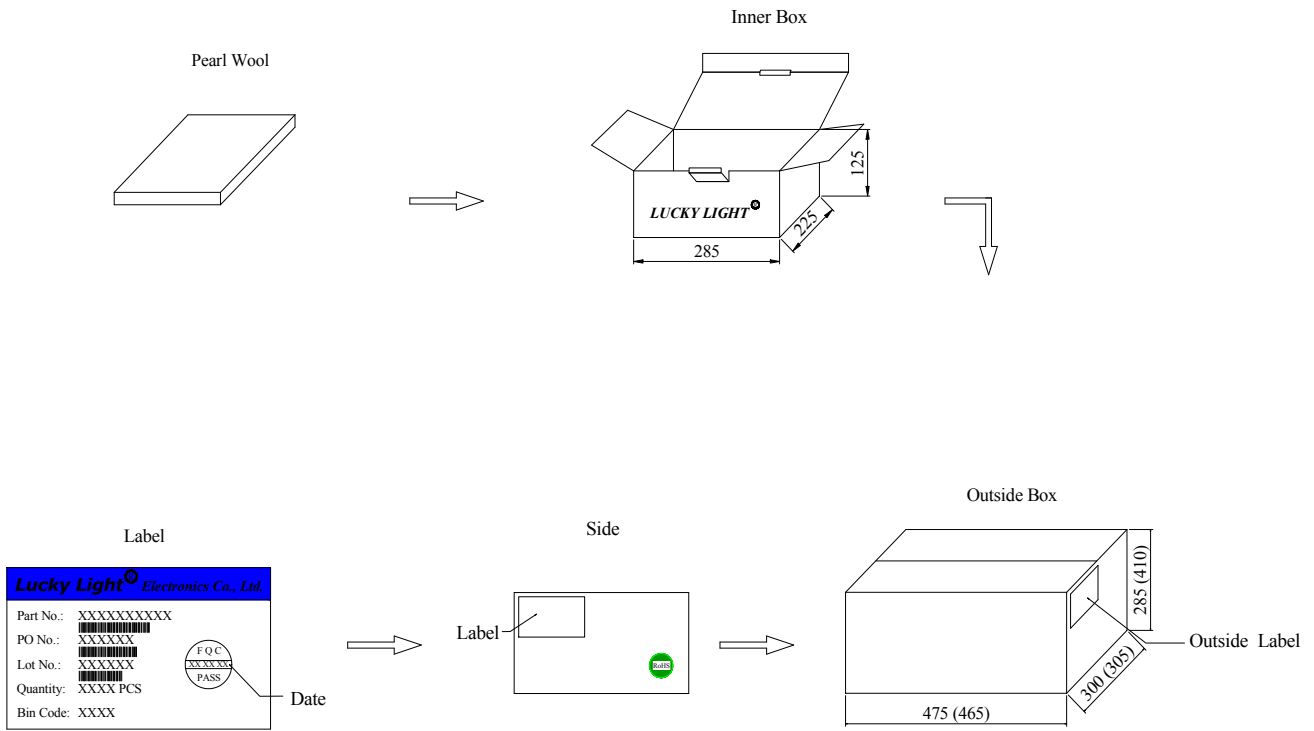

Technical Data Sheet

Terms and conditions for the usage of this document:

- a. The information included in this document reflects representative usage scenarios and is intended for technical reference only.
- b. The part number, type, and specifications mentioned in this document are subject to future change and improvement without notice. Before production usage customer should refer to the latest datasheet for the updated specifications.
- c. When using the products referenced in this document, please make sure the product is being operated within the environmental and electrical limits specified in the datasheet. If customer usage exceeds the specified limits, LuckyLight will not be responsible for any subsequent issues.
- d. The information in this document applies to typical usage in consumer electronics applications. If customer's application has special reliability requirements or have life-threatening liabilities, such as automotive or medical usage, please consult with LuckyLight representative for further assistance.
- e. The contents and information of this document may not be reproduced or re-transmitted without permission by LuckyLight.
- f. Over-current-proof
Customer must apply resistors for protection, otherwise slight voltage shift will cause big current change (Burn out will happen).

g. Storage

- 1. Before opening the package, the LEDs should be kept at 30°C or less and 80%RH or less.
- 2. The LEDs should be used within a year.
- 3. After opening the package, the LEDs should be kept at 30°C or less and 60%RH or less.

h. ESD (Electrostatic Discharge)

Static Electricity or power surge will damage the LED. Suggestions to prevent ESD damage:

IUse of a conductive wrist band or anti-electrostatic glove when handling these LEDs.

IAll devices, equipment, and machinery must be properly grounded.

IWork tables, storage racks, etc. should be properly grounded.

Technical Data Sheet

Through Hole Display Mounting Method

Lead Forming:

1. Do not bend the component leads by hand without proper tools.
2. The leads should be bent by clinching the upper part of the lead firmly such that the bending force is not exerted on the plastic body.

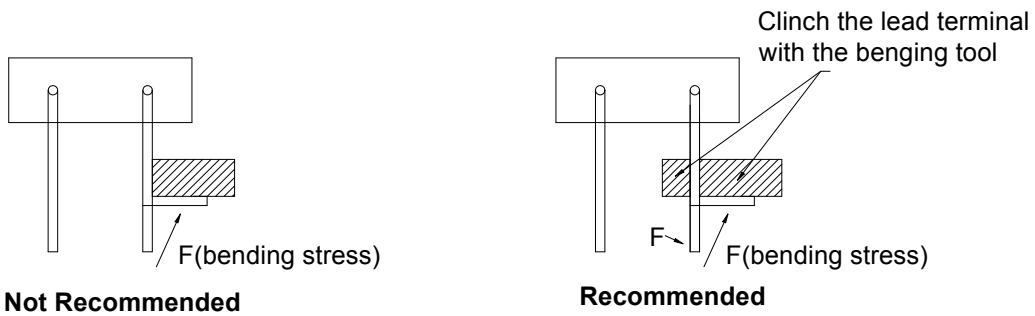

Installation:

1. The installation process should not apply stress to the lead terminals.
2. When inserting for assembly, ensure the terminal pitch matches the substrate board's hole pitch to prevent spreading or pinching the lead terminals.

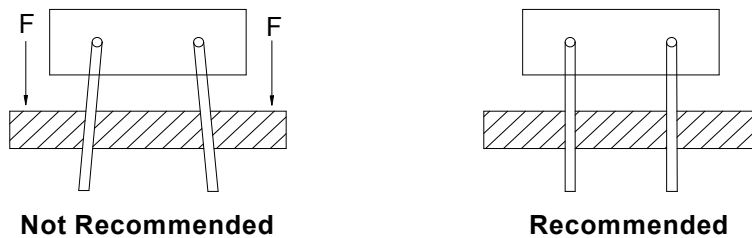

3. The component shall be placed at least 5mm from edge of PCB to avoid damage caused excessive heat during wave soldering.

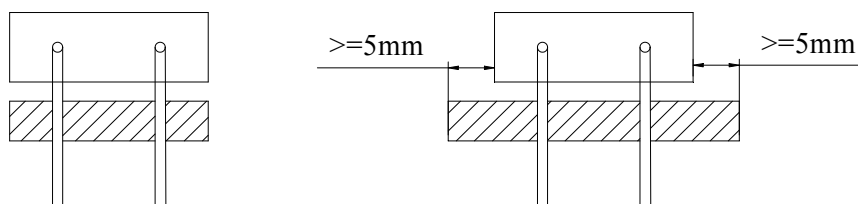

Technical Data Sheet

Soldering Iron

Each terminal is to go to the tip of soldering iron temperature less than 260°C for 5 seconds within once in less than the soldering iron capacity 25W. Leave two seconds and more intervals, and do soldering of each terminal. Be careful because the damage of the product is often started at the time of the hand solder.

Soldering

1. When soldering, for Lamp without stopper type and must be leave a minimum of 3mm clearance from the base of the lens to the soldering point.
2. When soldering, for Lamp without stopper type and must be leave a minimum of 3mm clearance from the base of the lens to the soldering point.
3. To avoided the Epoxy climb up on lead frame and was impact to non-soldering problem, dipping the lens into the solder must be avoided.
4. Do not apply any external stress to the lead frame during soldering while the LED is at high temperature.

Recommended soldering conditions:

Soldering Iron	
Temperature	300°C Max.
Soldering Time	3 sec. Max. (one time only)

Note: Excessive soldering temperature and / or time might result in deformation of the LED lens or catastrophic failure of the LED.

Soldering General Notes:

1. Through-hole displays are incompatible with reflow soldering.
2. If components will undergo multiple soldering processes, or other processes where the omponents may be subjected to intense heat, please check with luckyLight for compatibility.

Technical Data Sheet

Cleaning:

1. Mild “no-clean” fluxes are recommended for use in soldering.
2. If cleaning is required, luckyLight recommends to wash components with water only.
Do not use harsh organic solvents for cleaning because they may damage the plastic parts.
3. The cleaning process should take place at room temperature and the devices should not be washed for more than one minute.
4. When water is used in the cleaning process, immediately remove excess moisture from the component with forced-air drying afterwards.

Circuit Design Notes:

1. Protective current-limiting resistors may be necessary to operate the LEDs within the specified range.
2. LEDs mounted in parallel should each be placed in series with its own current-limiting resistor.

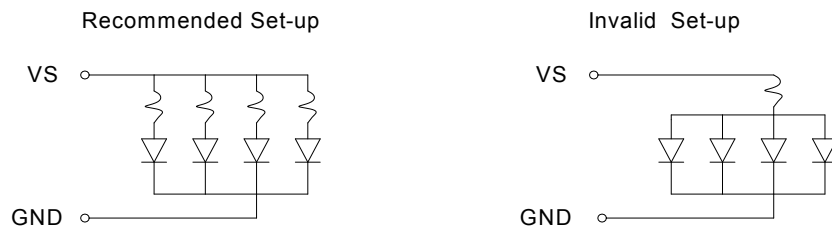

3. The driving circuit should be designed to protect the LED against reverse voltages and transient voltage spikes when the circuit is powered up or shut down.
4. The safe operating current should be chosen after considering the maximum ambient temperature of the operating environment.
5. Prolonged reverse bias should be avoided, as it could cause metal migration, leading to an increase in leakage current or causing a short circuit.