

R3030ERGB-001-1.5W

3.0x3.0mm, Multi-color LED

Surface Mount PLCC-6 LED Indicator



Technical Data Sheet

Features:

- Emc package.
- Colorless clear window.
- Super luminosity LED.
- Several colors available.
- Built in 3 LED chips.
- Wide viewing angle.
- High performance.
- Industry standard footprint.
- Computable with automatic placement equipment.
- Soldering methods: Reflow Soldering.
- The product itself will remain within RoHS compliant Version.

Descriptions:

- The R3030E series is available in soft red, orange, yellow, green, blue and white. Due to the package design, the LED has wide viewing angle and optimized light coupling by inter reflector. This feature makes the SMT TOP LED ideal for light pipe application. The low current requirement makes this device ideal for portable equipment or any other application where power is at a premium.

Applications:

- Reading lights (car, bus, aircraft).
- Portable (flashlight, bicycle).
- Mini-accent / Up lighters / Down lighters / Orientation.
- Bollards / Security / Garden.
- Cove / Under shelf / Task.
- Automotive rear combination lamps.
- Traffic signaling / Beacons / Rail crossing and Wayside.
- Indoor / Outdoor Commercial and Residential Architectural.
- Edge-lit signs (Exit, point of sale).

R3030ERGB-001-1.5W

3.0x3.0mm, Multi-color LED

Surface Mount PLCC-6 LED Indicator



Technical Data Sheet

Part No.	Emitting Color	Lens Color
R3030ERGB-001-1.5W	R Red	Water Clear
	G Pure Green	
	B Blue	

Package Dimension:

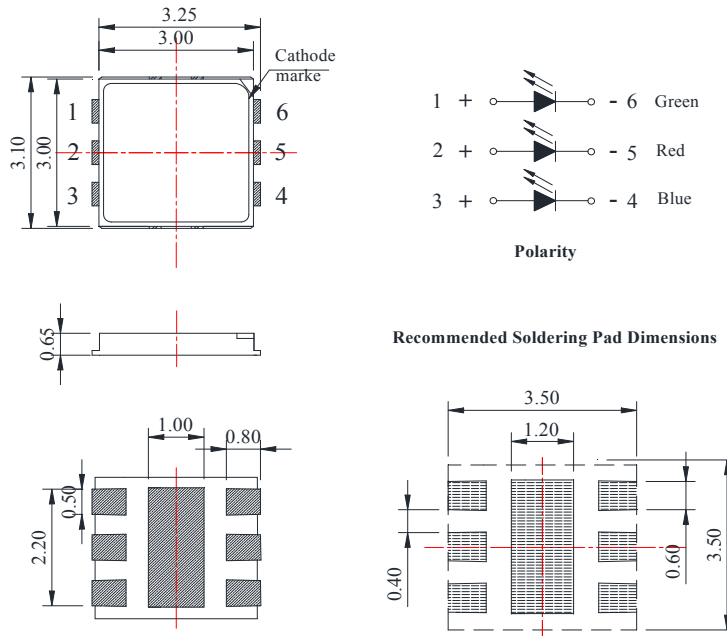

Notes:

1. All dimensions are in millimeters (inches).
2. Tolerance is ± 0.25 mm (.010") unless otherwise noted.
3. Protruded resin under flange is 1.00mm (.039") max.

R3030ERGB-001-1.5W

3.0x3.0mm, Multi-color LED

Surface Mount PLCC-6 LED Indicator



Technical Data Sheet

Absolute Maximum Ratings at Ta=25°C

Parameters		Symbol	Max.	Unit
Power Dissipation	R	PD	360	mW
	G			
	B			
Peak Forward Current (Per Chip) ^(a)		IFP	200	mA
Forward Current (Per Chip) ^(b)	R	IF	150	mA
	G			
	B			
Reverse Voltage (Per Chip)		VR	5	V
Electrostatic Discharge (HBM)	R	ESD	2000	V
	G			
	B			
Operating Temperature Range		Topr	-40°C to +85°C	
Storage Temperature Range		Tstg	-40°C to +100°C	
Lead Soldering Temperature [4mm (.157") From Body]		Tsld	260°C for 5 Seconds	

Notes:

- a. Derate linearly as shown in derating curve.
- b. Duty Factor = 10%, Frequency = 1 kHz.

R3030ERGB-001-1.5W

3.0x3.0mm, Multi-color LED

Surface Mount PLCC-6 LED Indicator



Technical Data Sheet

Electrical Optical Characteristics at Ta=25°C

Parameters	Symbol	Emitting Color	Min.	Typ.	Max.	Unit	Test Condition
Luminous Flux ^(a)	Φ_v	R	13	15	---	LM	IF=150mA
		G	30	35	---		
		B	7	9	---		
Viewing Angle ^(b)	$2\theta_{1/2}$	R	---	120	---	Deg	IF=150mA
		G	---	120	---		
		B	---	120	---		
Peak Emission Wavelength	λ_p	R	---	632	---	nm	IF=150mA
		G	---	520	---		
		B	---	462	---		
Dominant Wavelength ^(c)	λ_d	R	---	624	---	nm	IF=150mA
		G	---	525	---		
		B	---	457	---		
Spectral Line Half-Width	$\Delta\lambda$	R	---	20	---	nm	IF=150mA
		G	---	35	---		
		B	---	25	---		
Forward Voltage	VF	R	1.60	2.15	2.40	V	IF=150mA
		G	2.80	3.20	3.80		
		B	2.80	3.20	3.80		
Reverse Current	IR	R	---	---	10	μA	$V_R=5V$
		G					
		B					

Notes:

- Luminous intensity is measured with a light sensor and filter combination that approximates the CIE eye-response curve.
- $2\theta_{1/2}$ is the o-axis angle where the luminous intensity is 1/2 the peak intensity.
- The dominant wavelength (λ_d) is derived from the CIE chromaticity diagram and represents the single wavelength which defines the color of the device.

R3030ERGB-001-1.5W

3.0x3.0mm, Multi-color LED

Surface Mount PLCC-6 LED Indicator



Technical Data Sheet

Typical Electrical / Optical Characteristics Curves (25°C Ambient Temperature Unless Otherwise Noted)

Red:

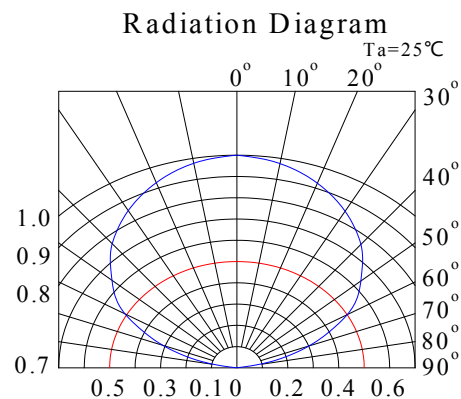
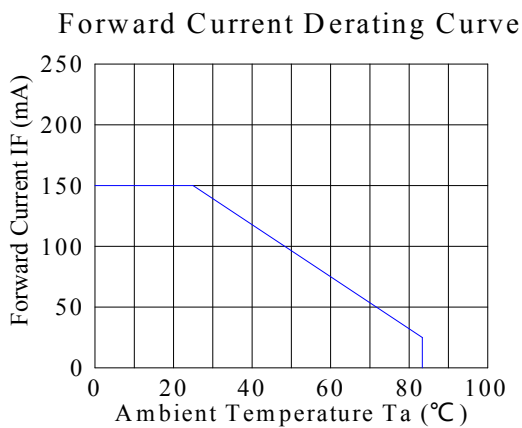
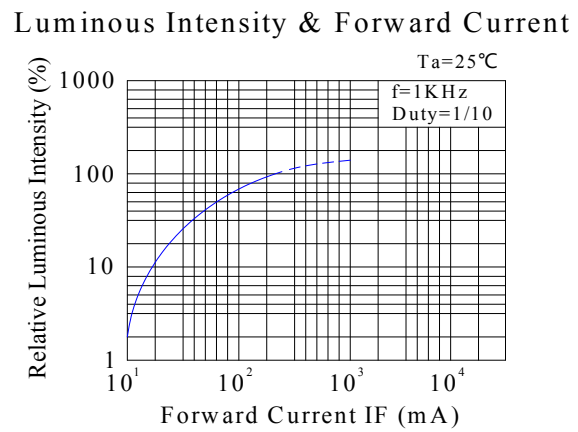
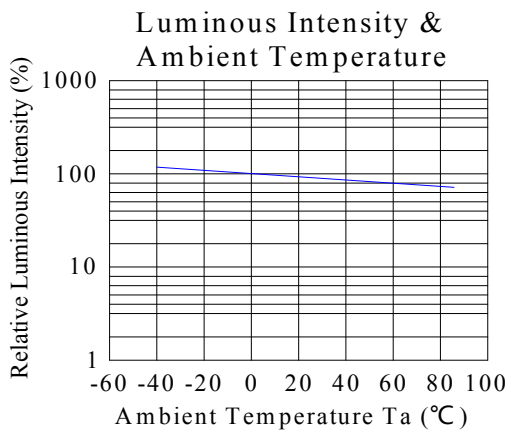
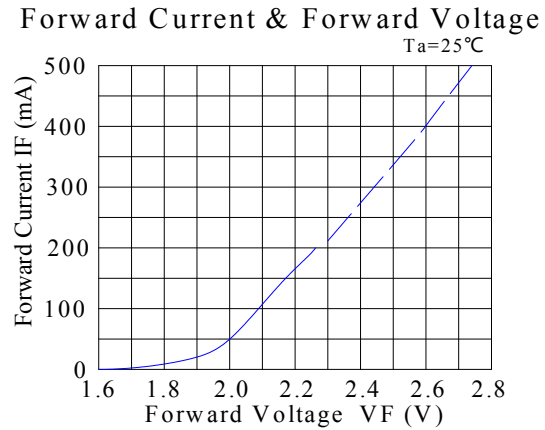
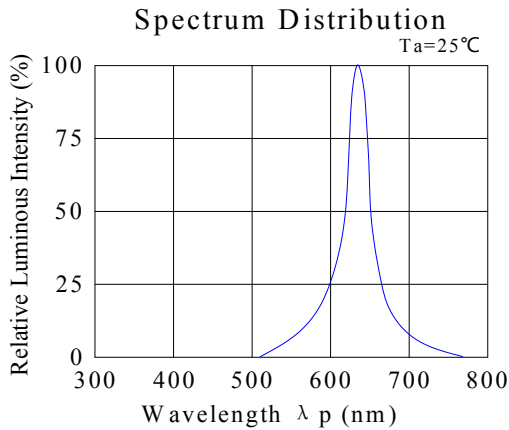

R3030ERGB-001-1.5W

3.0x3.0mm, Multi-color LED

Surface Mount PLCC-6 LED Indicator



Technical Data Sheet

Green:

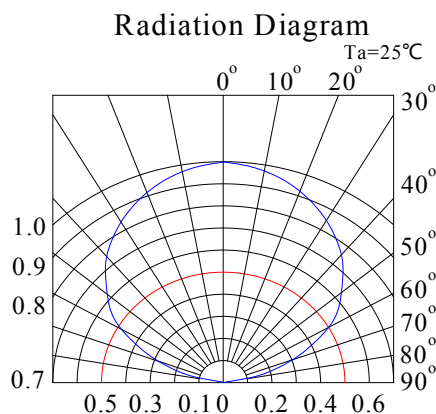
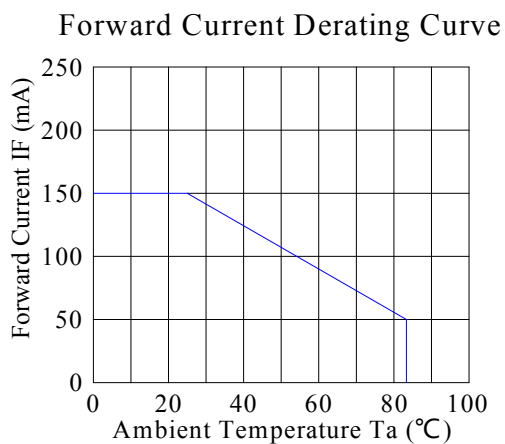
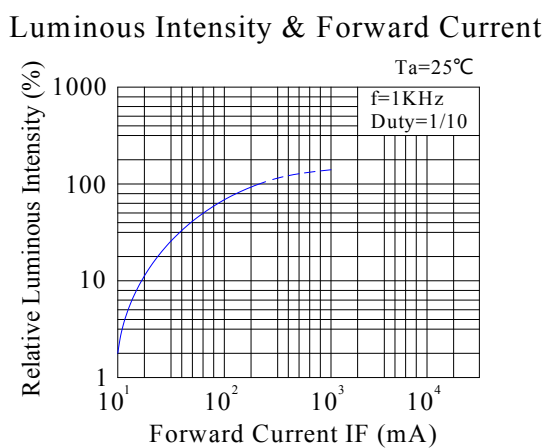
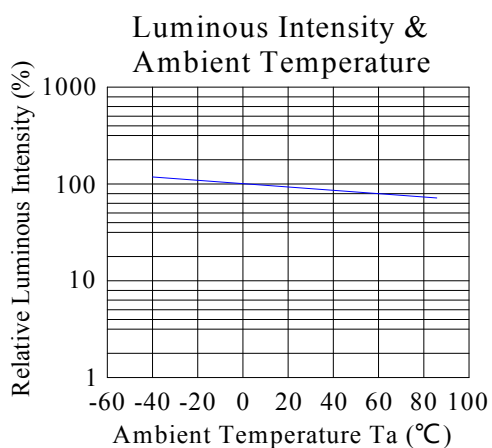
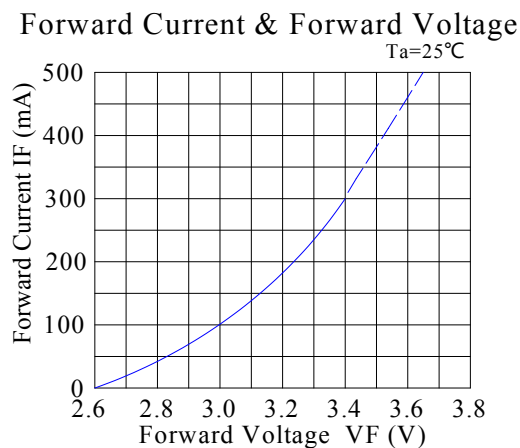
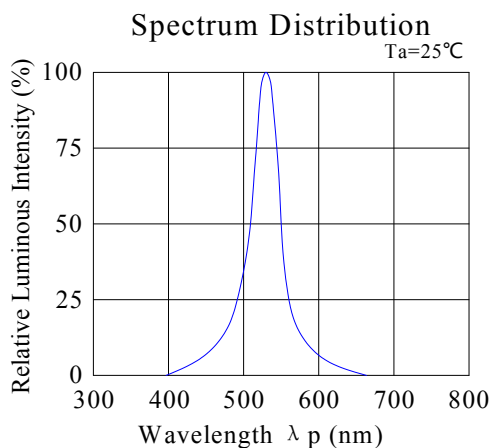

R3030ERGB-001-1.5W

3.0x3.0mm, Multi-color LED

Surface Mount PLCC-6 LED Indicator



Technical Data Sheet

Blue:

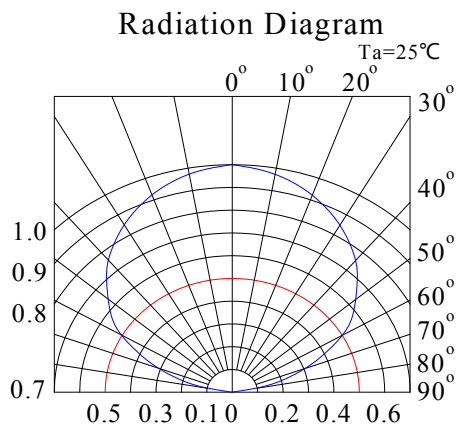
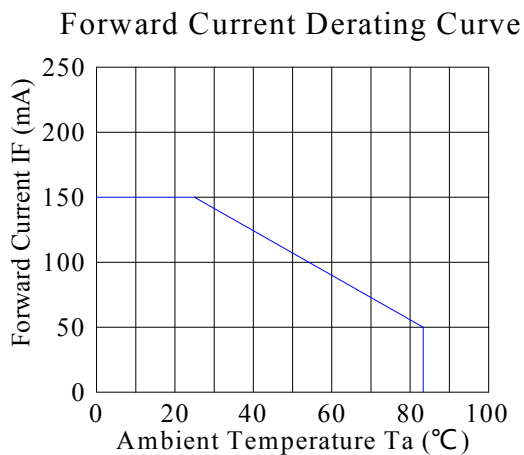
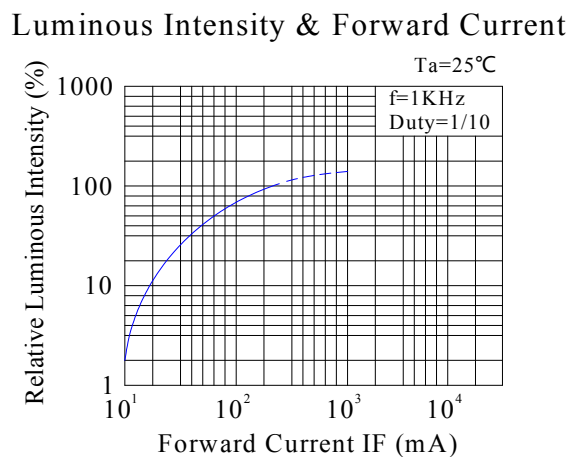
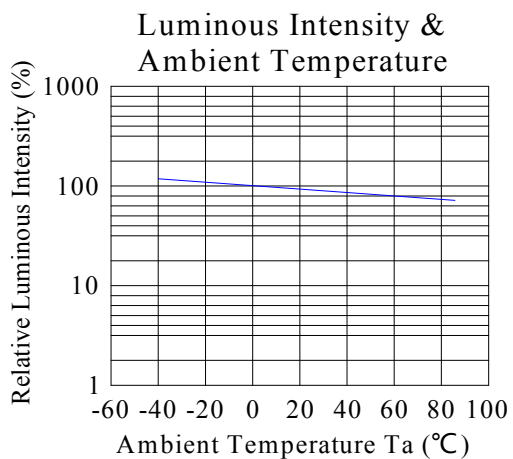
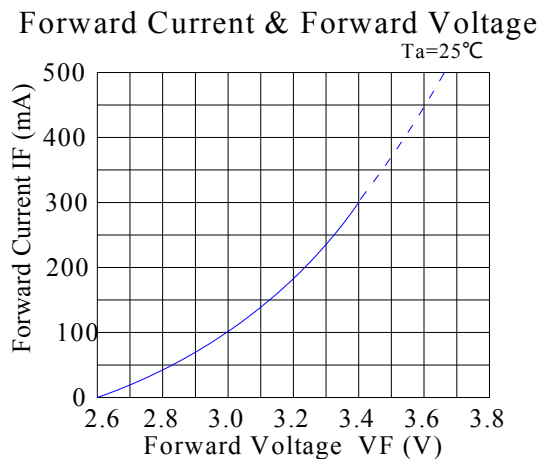
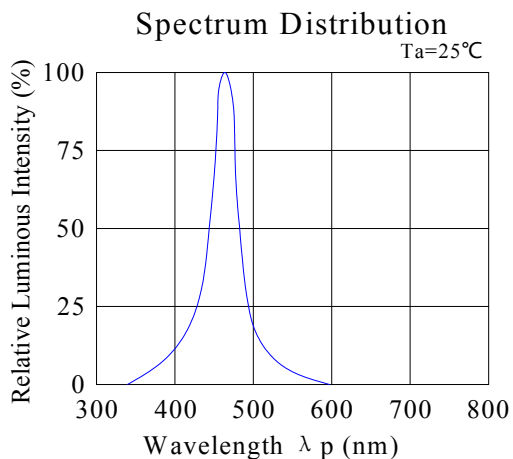

R3030ERGB-001-1.5W

3.0x3.0mm, Multi-color LED

Surface Mount PLCC-6 LED Indicator



Technical Data Sheet

Reel Dimensions:

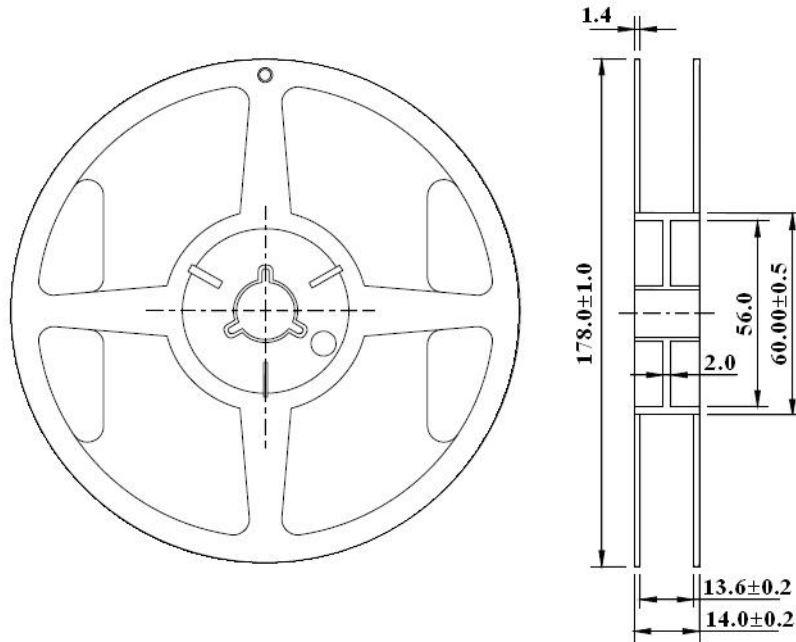

Carrier Tape Dimensions:

Loaded quantity 5000 pcs per reel.

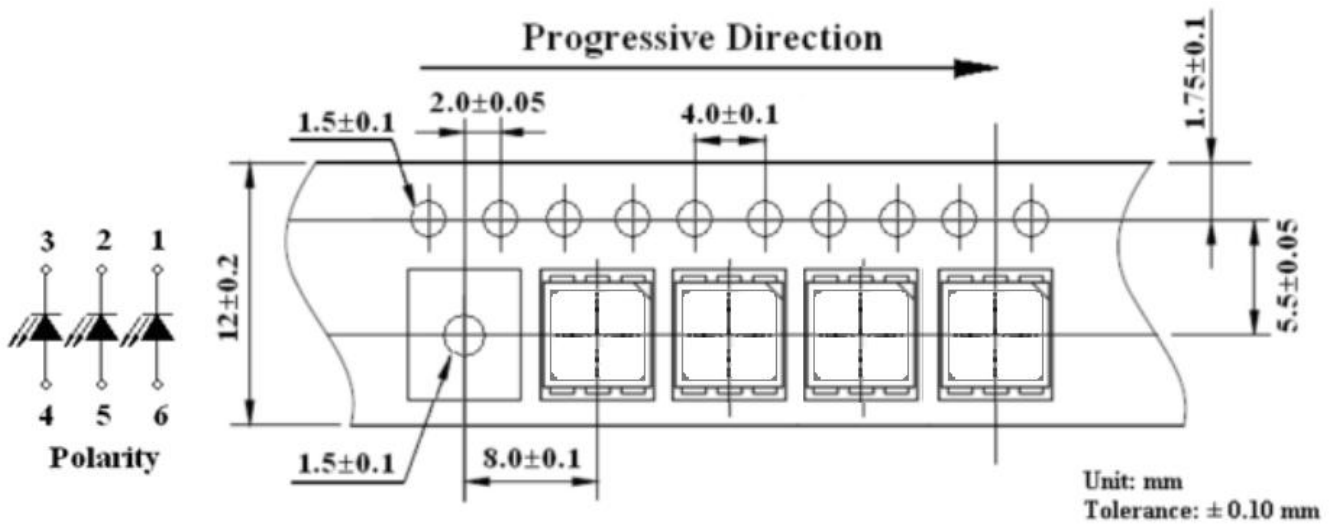

R3030ERGB-001-1.5W

3.0x3.0mm, Multi-color LED

Surface Mount PLCC-6 LED Indicator

Technical Data Sheet

CAUTIONS

1. Handling Precautions:

- 1.1. Handle the component along the side surfaces by using forceps or appropriate tools.
- 1.2. Do not directly touch or handle the silicone lens surface. It may damage the internal circuitry.
- 1.3. Do not stack together assembled PCBs containing exposed LEDs. Impact may scratch the silicone lens or damage the internal circuitry.

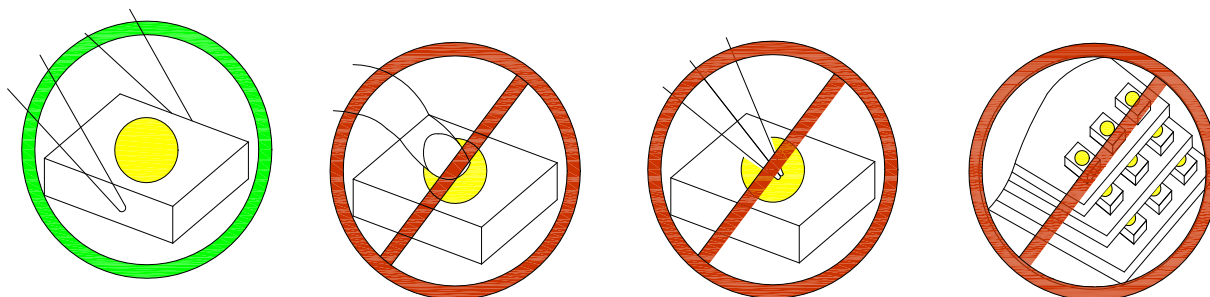

Compare to epoxy encapsulant that is hard and brittle, silicone is softer and flexible. Although its characteristic significantly reduces thermal stress, it is more susceptible to damage by external mechanical force. As a result, special handling precautions need to be observed during assembly using silicone encapsulated LED products. Failure to comply might lead to damage and premature failure of the LED.

2. Storage

- 2.1. Do not open moisture proof bag before the products are ready to use.
- 2.2. Before opening the package, the LEDs should be kept at 30°C or less and 60%RH or less.
- 2.3. The LEDs should be used within a year.
- 2.4. After opening the package, the LEDs should be kept at 30°C or less and 60%RH or less.
- 2.5. The LEDs should be used within 24 hours after opening the package.
- 2.6. If the moisture adsorbent material has fabled away or the LEDs have exceeded the storage time, baking treatment should be performed using the following conditions. Baking treatment: 65±5°C for 24 hours.

Technical Data Sheet

3. Soldering Condition

3.1. Pb-free solder temperature profile

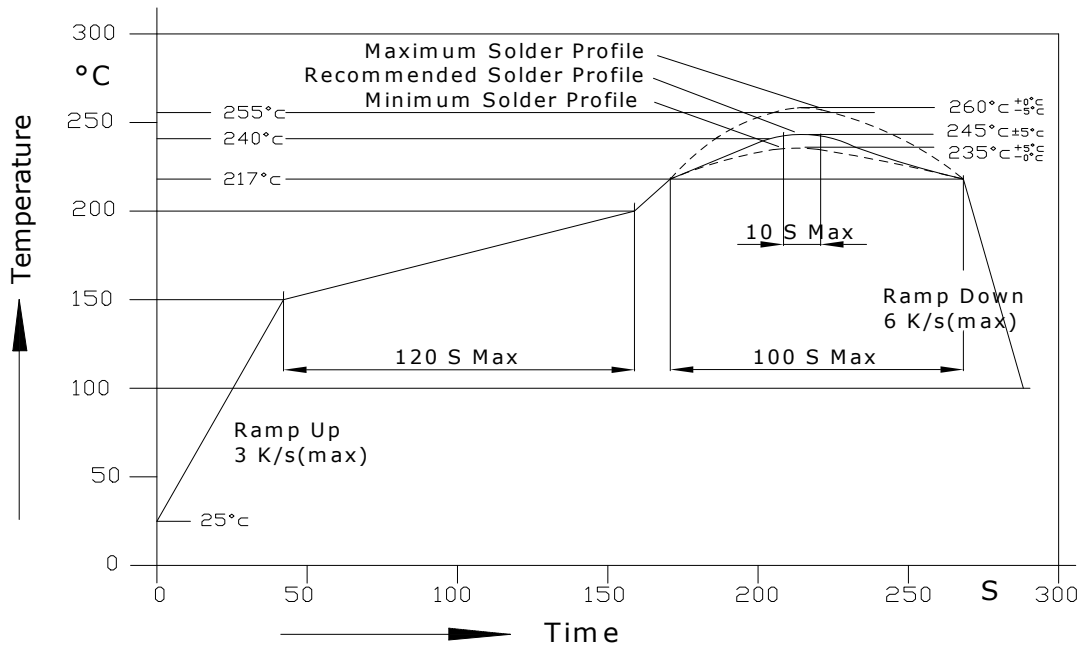

3.2. Reflow soldering should not be done more than two times.

3.3. When soldering, do not put stress on the LEDs during heating.

3.4. After soldering, do not warp the circuit board.

3.5. Recommended soldering conditions:

Reflow soldering		Soldering iron	
Pre-heat	150~200°C	Temperature	300°C Max.
Pre-heat time	120 sec. Max.	Soldering time	3 sec. Max.
Peak temperature	250°C Max.		(one time only)
Soldering time	10 sec. Max.(Max. two times)		

3.6. Because different board designs use different number and types of devices, solder pastes, reflow ovens, and

R3030ERGB-001-1.5W

3.0x3.0mm, Multi-color LED

Surface Mount PLCC-6 LED Indicator

LuckyLight

Technical Data Sheet

circuit boards, no single temperature profile works for all possible combinations.

However, you can successfully mount your packages to the PCB by following the proper guidelines and PCB-specific characterization.

4. Drive Method

4.1. An LED is a current-operated device. In order to ensure intensity uniformity on multiple LEDs connected in parallel in an application, it is recommended that a current limiting resistor be incorporated in the drive circuit, in series with each LED as shown in Circuit A below.

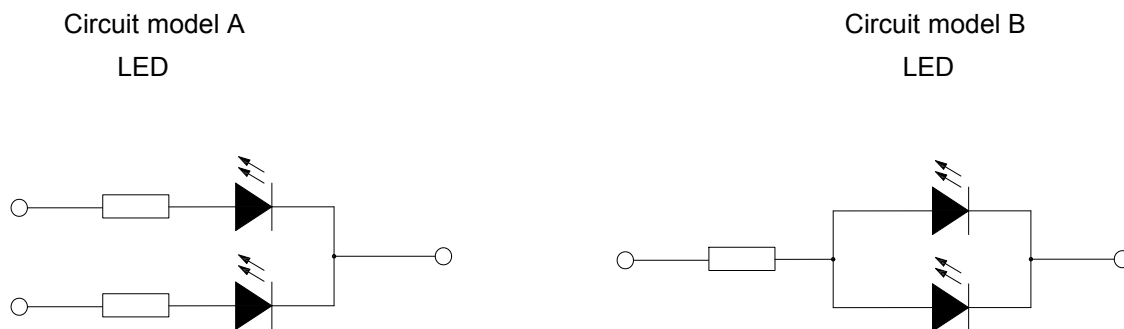

a. Recommended circuit.

b. The brightness of each LED might appear different due to the differences in the I-V characteristics of those LEDs.

5. ESD (Electrostatic Discharge):

Static Electricity or power surge will damage the LED. Suggestions to prevent ESD damage:

- Use of a conductive wrist band or anti-electrostatic glove when handling these LEDs.
- All devices, equipment, and machinery must be properly grounded.
- Work tables, storage racks, etc. should be properly grounded.
- Use ion blower to neutralize the static charge which might have built up on surface of the LED's plastic lens as a result of friction between LEDs during storage and handling.

ESD-damaged LEDs will exhibit abnormal characteristics such as high reverse leakage current, low forward voltage, or "no lightup" at low currents. To verify for ESD damage, check for "lightup" and V_f of the suspect LEDs at low currents. The V_f of "good" LEDs should be $>2.0V@0.1mA$ for InGaN product and $>1.4V@0.1mA$ for AlInGaP product.

R3030ERGBC-001-1.5W

3.0x3.0mm, Multi-color LED

Surface Mount PLCC-6 LED Indicator



Technical Data Sheet

Terms and conditions for the usage of this document

1. The information included in this document reflects representative usage scenarios and is intended for technical reference only.
2. The part number, type, and specifications mentioned in this document are subject to future change and improvement without notice. Before production usage customer should refer to the latest datasheet for the updated specifications.
3. When using the products referenced in this document, please make sure the product is being operated within the environmental and electrical limits specified in the datasheet. If customer usage exceeds the specified limits, LuckyLight will not be responsible for any subsequent issues.
4. The information in this document applies to typical usage in consumer electronics applications. If customer's application has special reliability requirements or have life-threatening liabilities, such as automotive or medical usage, please consult with LuckyLight representative for further assistance.
5. The contents and information of this document may not be reproduced or re-transmitted without permission by LuckyLight.