

S172RM-C45-E1B

2.0mm × 1.25mm (0805) Red Surface Mount Chip LED

Diffused Lens Top-View Mono-Color Chip LED Indicator



Features

- High brightness and uniform light distribution
- Low power consumption with solid-state reliability
- Wide viewing angle with diffused optical lens
- Compatible with automatic placement and IR / vapor-phase reflow soldering
- Standard 2.0mm × 1.25mm (0805) top-view SMD package
- Packaged in 8mm tape on 7-inch reel for automated handling
- Fully compliant with RoHS and EU REACH directives

Description

The S172RM-C45-E1B is a 2.0mm × 1.25mm (0805) top-view surface-mount chip LED that emits a clear, saturated red and stands just 0.8mm thin. Engineered for high-visibility indication in space-constrained designs, its diffused optical-grade lens delivers a wide viewing angle and uniform light output. The ultra-low-profile epoxy package enables higher board density, slim product profiles, and reliable performance across demanding operating conditions.

Applications

- Status and diagnostic indicators
- Backlighting for switches, symbols, and small displays
- Networking, telecom, and IT infrastructure
- Industrial control panels and automation equipment
- Home appliances and smart consumer electronics
- Handheld and portable electronic devices

Selection Guide

Part No.	Emitting Color	Lens Color
S172RM-C45-E1B	Red	White Diffused

Package Dimensions

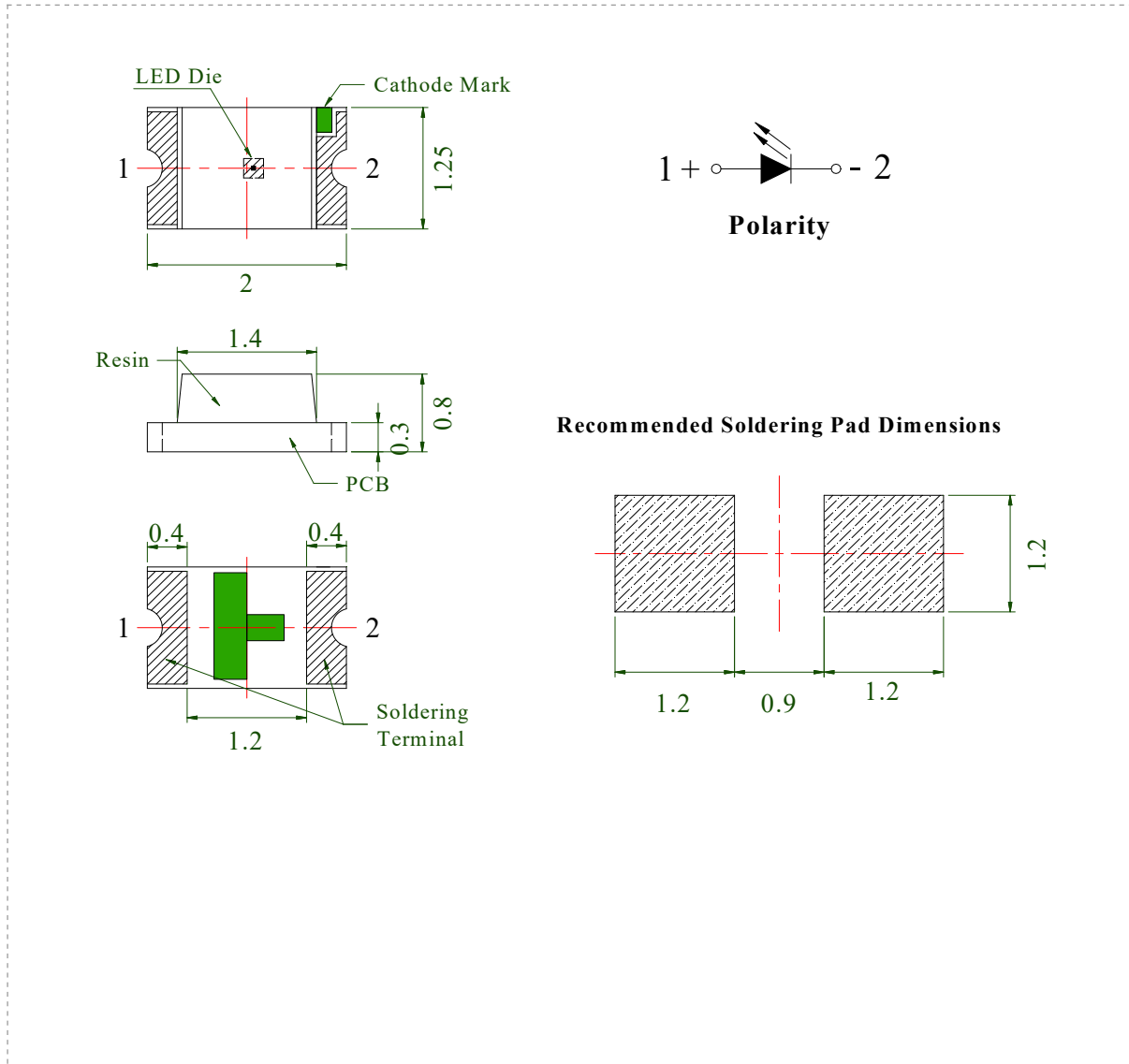

Notes:

1. All dimensions are in millimeters (inches).
2. Tolerance is ± 0.10 mm (.004") unless otherwise noted.

Absolute Maximum Ratings (T_a = 25 °C)

Parameter	Symbol	Max.	Unit
Power Dissipation	P _D	72	mW
Peak Forward Current ¹	I _{FP}	100	mA
DC Forward Current ²	I _F	30	mA
Reverse Voltage	V _R	5	V
Operating Temperature Range	T _{opr}	-40 to +85	°C
Storage Temperature Range	T _{stg}	-40 to +85	°C
Soldering Temperature (5 s)	T _{slid}	260	°C

Notes:

1. Duty Factor = 10%, Frequency = 1 kHz.
2. Derate linearly as shown in the derating curve.

Electrical / Optical Characteristics (T_a = 25 °C)

Parameter	Symbol	Min.	Typ.	Max.	Unit	Test Condition
Luminous Intensity ¹	I _V	5.3	14	-	mcd	I _F = 10 mA
		11.7	31.5	-	mcd	I _F = 20 mA
Viewing Angle ²	2θ _½	-	140	-	deg.	I _F = 20 mA
Peak Emission Wavelength	λ _p	-	660	-	nm	I _F = 20 mA
Dominant Wavelength ³	λ _d	-	645	-	nm	I _F = 20 mA
Spectral Line Half-Width	Δλ	-	20	-	nm	I _F = 20 mA
Forward Voltage	V _F	1.6	2.0	2.4	V	I _F = 20 mA
Reverse Current	I _R	-	-	10	μA	V _R = 5 V

Notes:

1. Luminous intensity (I_V) is measured using a light sensor and filter combination that approximates the CIE eye-response curve, with a measurement tolerance of ±15%.
2. 2θ_½ is the off-axis angle where the luminous intensity is half of the peak intensity.
3. The dominant wavelength (λ_d) is derived from the CIE chromaticity diagram and represents the single wavelength that defines the perceived color of the device.

Typical Electrical / Optical Characteristics Curves (Ta = 25 °C)

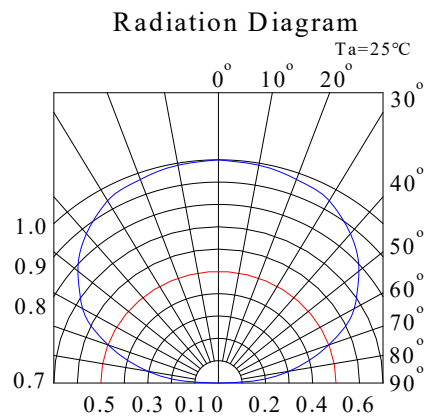
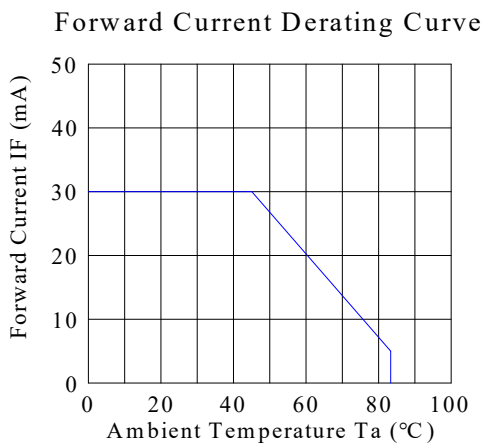
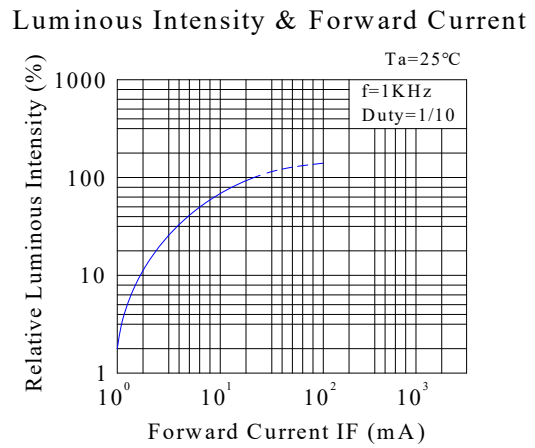
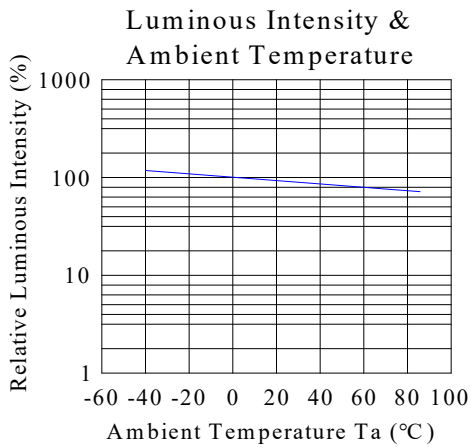
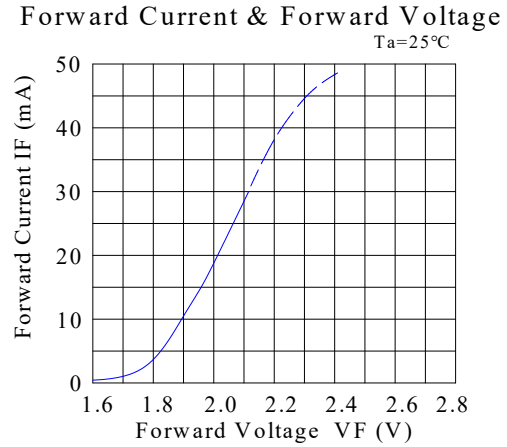
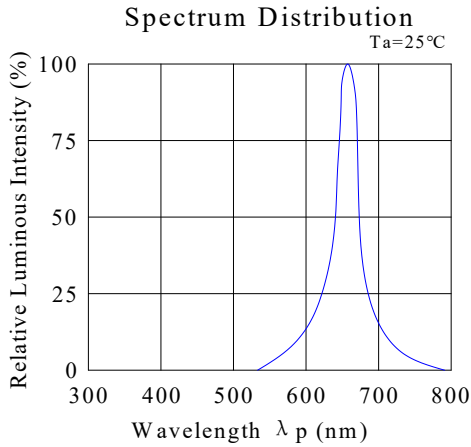

Reel & Carrier Tape Dimensions

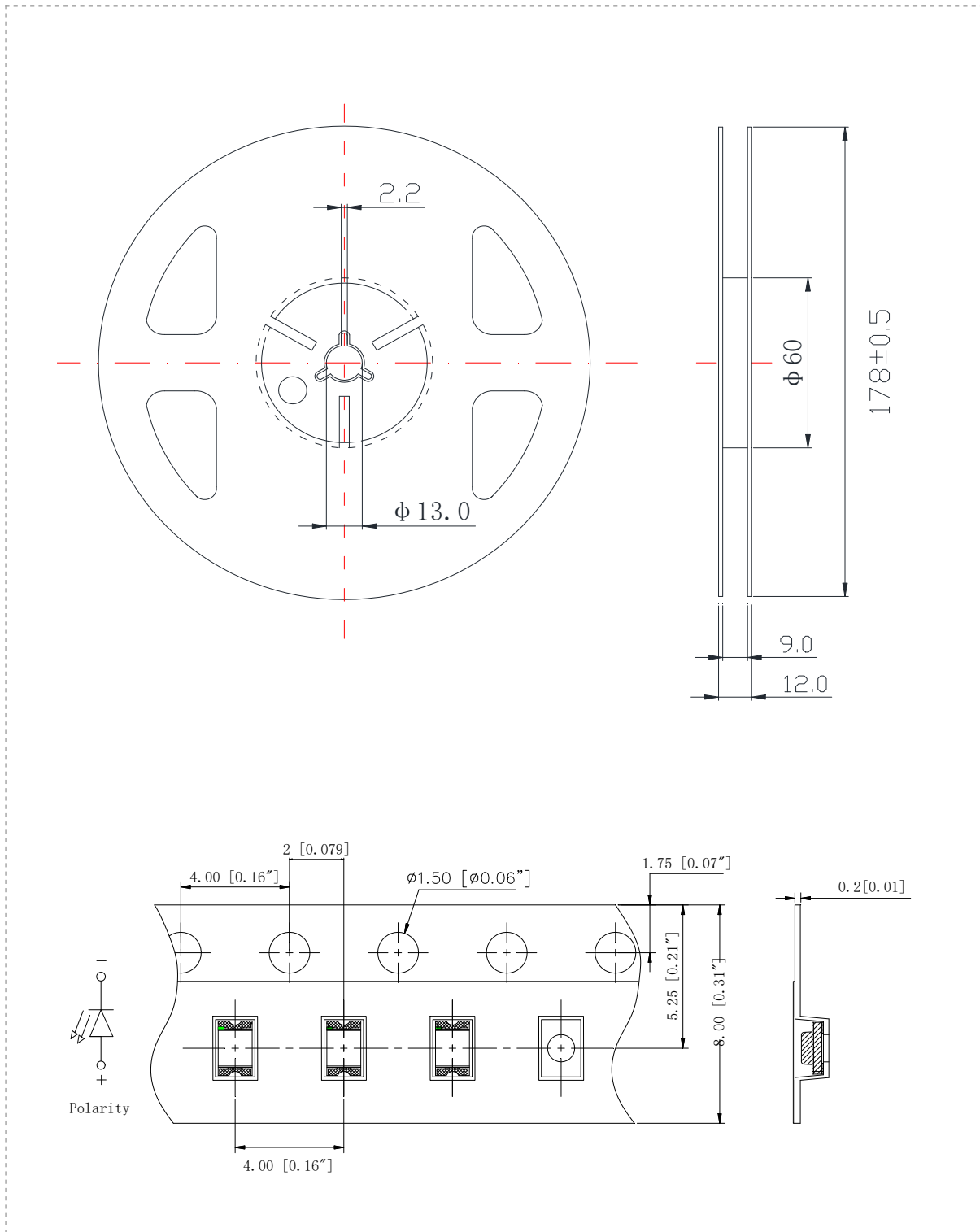

Standard Packing Quantity (SPQ): 4000 pcs per reel.

Doc. No.: D-80-100C45

Date: June 7, 2026

Revision: Rev-1

Email: sales@luckylight.cn

Ref No: S1708-LS0805

Website: www.luckylight.cn

Copyright © 2026 LuckyLight All Rights Reserved

Page: 6 / 12

Packing & Label Specifications

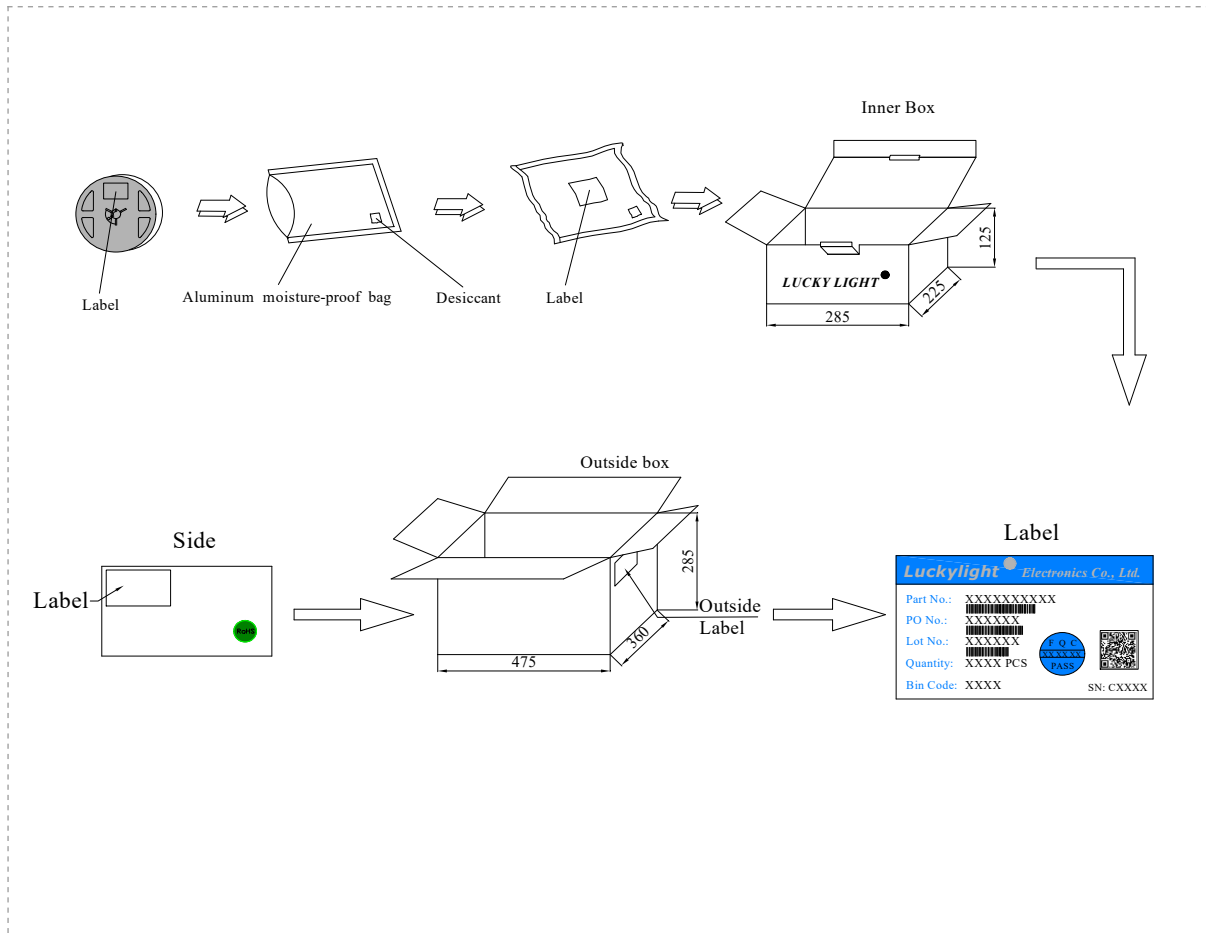

Precautions

1. Circuit Design & Over-Current Protection

LEDs are current-operated devices. A current-limiting resistor must be connected in series with each LED. A small voltage shift can cause a large change in current, which may result in device failure or permanent burnout.

2. Storage & Moisture Control

- Do not open the moisture-proof bag until the products are ready to use.
- Before opening, store the LEDs at 30 °C or less and 60% RH or less.
- After opening, store at 30 °C or less and 60% RH or less, and use within **{{168}}** hours.
- If the desiccant has changed color or the storage time has been exceeded, perform baking at **{{65 ± 5 °C for 24 hours}}** before use.
- Avoid rapid ambient temperature transitions, particularly in high-humidity environments where condensation may occur.

3. Handling

Handle the component by its side surfaces using forceps or appropriate tooling. Do not apply mechanical stress to the lens surface during assembly. Use ionizing blowers to neutralize static charges that may accumulate on the lens during handling.

4. Soldering

Reflow soldering should not be performed more than twice. Do not apply stress to the LED during heating, and do not warp the circuit board after soldering. Excessive soldering temperature or duration may result in deformation of the lens or cause catastrophic failure of the device.

Pb-Free Reflow Temperature Profile

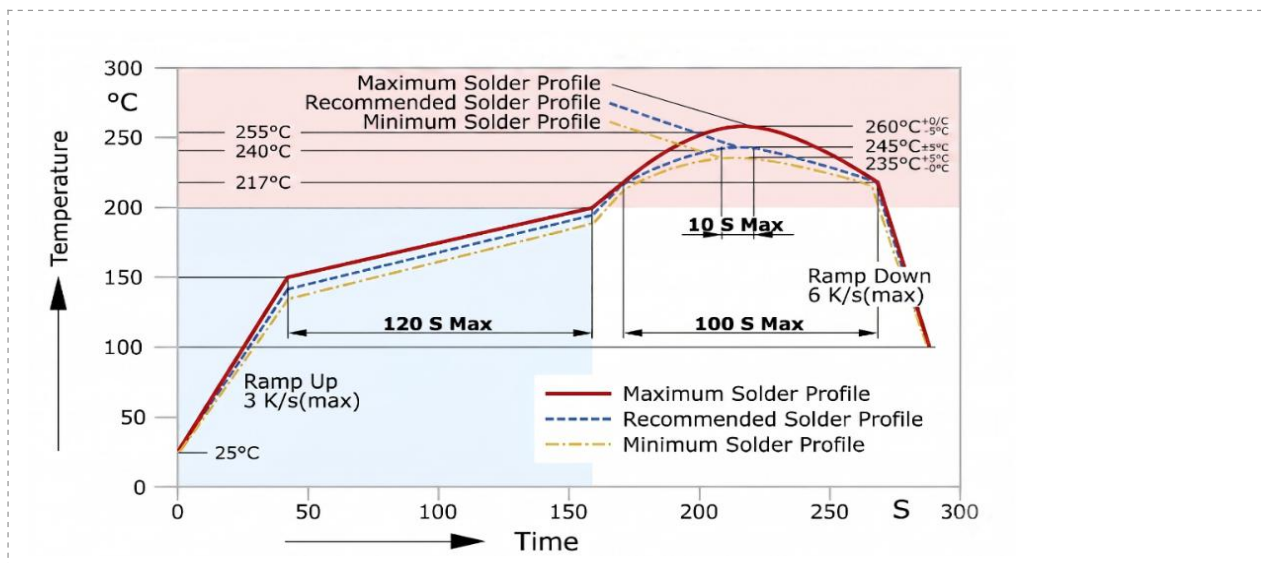

Reflow Soldering — Time / Rate Parameters

Parameter	Recommended Condition
Start temperature	25 °C
Preheat / soak range	150°C to 200°C
Preheat / soak time	120 s max
Liquidus temperature	217°C
Time above liquidus	100 s max
Recommended peak temperature	245°C ±5°C
Maximum peak temperature	260°C +0/-5°C
Ramp-up rate	3 K/s max
Ramp-down rate	6 K/s max
Time near peak	10 s max

Soldering Iron (Manual / Rework)

Parameter	Limit
Tip temperature	300 °C Max. (25 W Max.)
Soldering time	3 sec. Max. (One time only)

Note:

Because board designs, solder pastes, reflow ovens, and PCBs differ, no single temperature profile suits all combinations. Verify the profile with PCB-specific characterization.

5. Drive Method

To ensure luminous-intensity uniformity across multiple LEDs connected in parallel, incorporate a dedicated current-limiting resistor in series with each individual LED, as shown in Circuit A below.



A. Recommended circuit.

B. LED brightness may vary due to variations in individual I-V characteristics.

6. Rework

Rework should generally be avoided once the LEDs have been soldered. If rework is unavoidable, use a dual-head soldering iron and verify beforehand that the process will not degrade the electrical or optical characteristics of the LED.

7. Electrostatic Discharge (ESD)

Static electricity and surge voltage can damage the LED. Wear a conductive wrist strap or anti-static gloves, ensure all equipment and workbenches are properly grounded, and use ionizing blowers where appropriate. ESD-damaged LEDs may exhibit increased reverse leakage current, reduced forward voltage, or failure to illuminate at low currents.

To verify ESD damage, check forward voltage and illumination at low current. An undamaged LED should exhibit **VF > 1.4 V @ 0.1 mA (AlInGaP)** for this product family.

Disclaimers

The information provided in this document reflects representative usage scenarios and is intended for technical reference only.

Part numbers, product types, and specifications are subject to change or improvement without prior notice. Prior to mass production or design-in, customers must consult the latest version of the datasheet to verify the most up-to-date specifications.

When deploying the products referenced herein, ensure they are operated strictly within the environmental and electrical limits specified in this datasheet. LuckyLight assumes no liability or responsibility for any issues, malfunctions, or damages resulting from operation outside these specified limits.

The LEDs described in this document are intended for standard electronic equipment such as office automation, communication equipment, and general consumer electronics. For applications requiring exceptional reliability and safety—where a failure could directly jeopardize life or health, such as aviation, transportation, traffic control, medical life-support systems, or safety devices—please contact LuckyLight sales representatives in advance for technical consultation.

The contents of this document may not be reproduced or re-transmitted without permission from LuckyLight.

Revision History

Version	Date	Revision History	Page
Rev-1	June 7, 2026	Initial release	—