

S192W-W2-1AG

1.6x0.8mm, White LED
Surface Mount Chip LED Indicator

Technical Data Sheet

Features:

- Package in 8mm tape on 7" diameter reel.
- Compatible with automatic placement equipment.
- Compatible with infrared and vapor phase reflow solder process.
- Mono-color type.
- The product itself will remain within RoHS compliant version.

Descriptions:

- The S192 SMD LED is much smaller than lead frame type components, thus enable smaller board size, higher packing density, reduced storage space and finally smaller equipment to be obtained.
- Besides, lightweight makes them ideal for miniature applications, etc.

Applications:

- Backlighting in dashboard and switch.
- Telecommunication: Indicator and backlighting in telephone and fax.
- Flat backlight for LCD, switch and symbol.
- General use.

S192W-W2-1AG

1.6x0.8mm, White LED
Surface Mount Chip LED Indicator

Technical Data Sheet

Part No.	Emitting Color	Lens Color
S192W-W2-1AG	White	Yellow Diffused

Package Dimension:

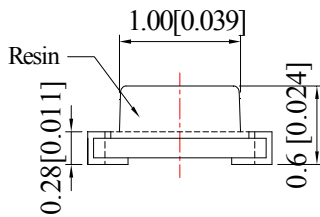
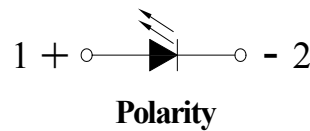
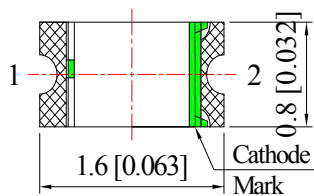

Recommended Soldering Pad Dimensions

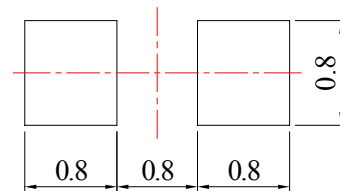

Unit: mm
Tolerance: ± 0.10 mm

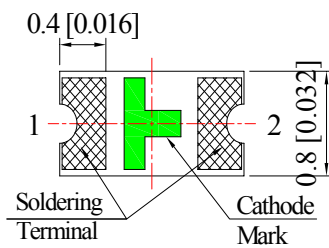

Notes:

1. All dimensions are in millimeters (inches).
2. Tolerance is ± 0.25 mm (.010") unless otherwise noted.

S192W-W2-1AG

1.6x0.8mm, White LED
Surface Mount Chip LED Indicator

Technical Data Sheet

Absolute Maximum Ratings at Ta=25°C

Parameters	Symbol	Max	Unit
Power Dissipation	Pd	90	mW
Peak Forward Current ^(a)	IFP	100	mA
DC Forward Current ^(b)	IF	25	mA
Reverse Voltage	VR	5	V
Electrostatic Discharge (HBM)	ESD	1000	V
Operating Temperature Range	Topr	-40°C to +85°C	
Storage Temperature Range	Tstg	-40°C to +85°C	
Soldering Temperature	Tsld	260°C for 5 Seconds	

Notes:

- a. Duty Factor = 10%, Frequency = 1 kHz
- b. Derate linearly as shown in derating curve.

Electrical Optical Characteristics at Ta=25°C

Parameters	Symbol	Min.	Typ.	Max.	Unit	Test Condition
Luminous Intensity ^(a)	IV	180	220	---	mcd	IF=5mA
		700	850	---	mcd	IF=20mA
Viewing Angle	2θ1/2	---	120	---	Deg	IF=20mA
Chromaticity Coordinates ^(b)	x	---	0.27	---		IF=20mA
	y	---	0.27	---		
Forward Voltage ^(c)	VF	2.50	2.80	3.20	V	IF=5mA
	VF	2.60	3.10	3.60	V	IF=20mA
Reverse Current	IR	---	---	10	μA	VR=5V

Notes:

- a. Luminous Intensity measurement tolerance: ±10%.
- b. Color coordinates measurement tolerance: ±0.015
- c. Forward voltage measurement tolerance: ±0.1V

S192W-W2-1AG

1.6x0.8mm, White LED
Surface Mount Chip LED Indicator



Technical Data Sheet

Typical Electrical / Optical Characteristics Curves (25°C Ambient Temperature Unless Otherwise Noted)

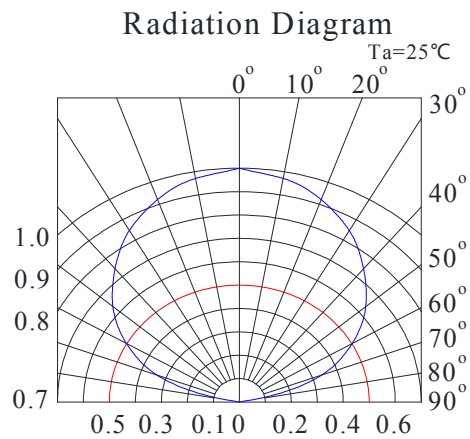
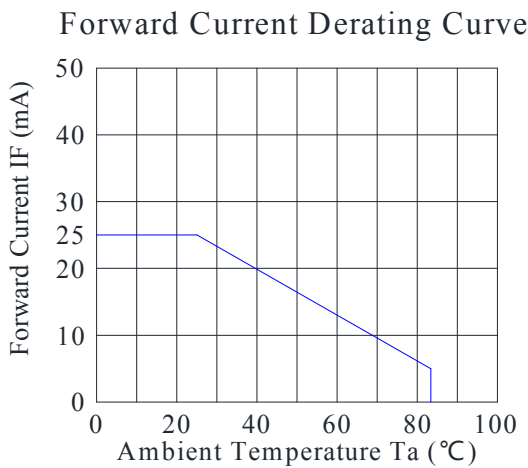
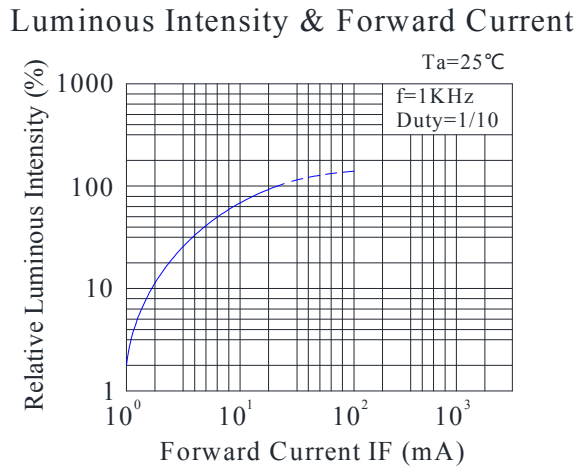
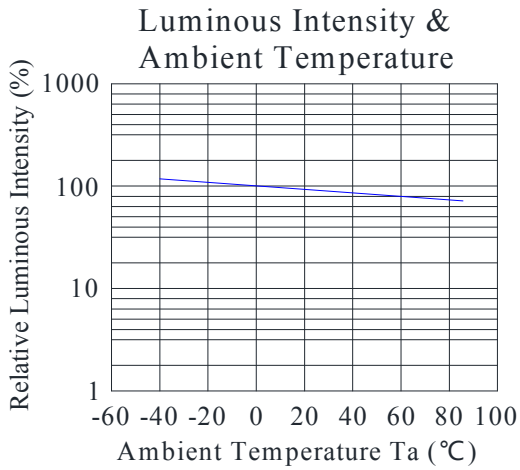
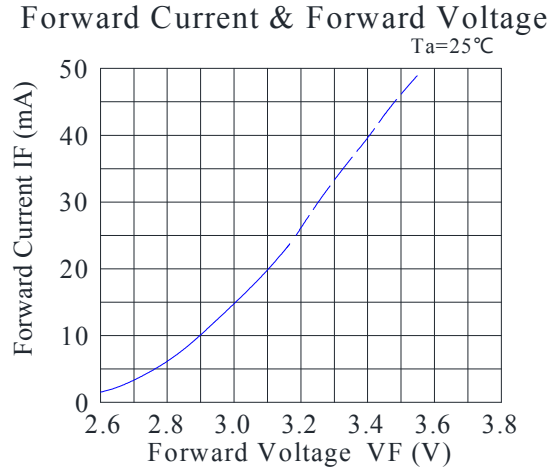
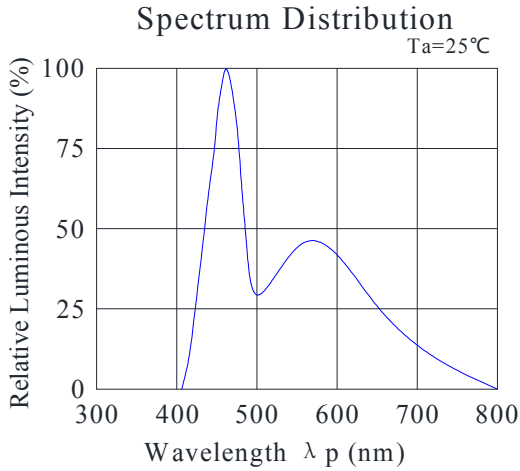

S192W-W2-1AG

1.6x0.8mm, White LED
Surface Mount Chip LED Indicator

Technical Data Sheet

CIE Chromaticity Diagram:

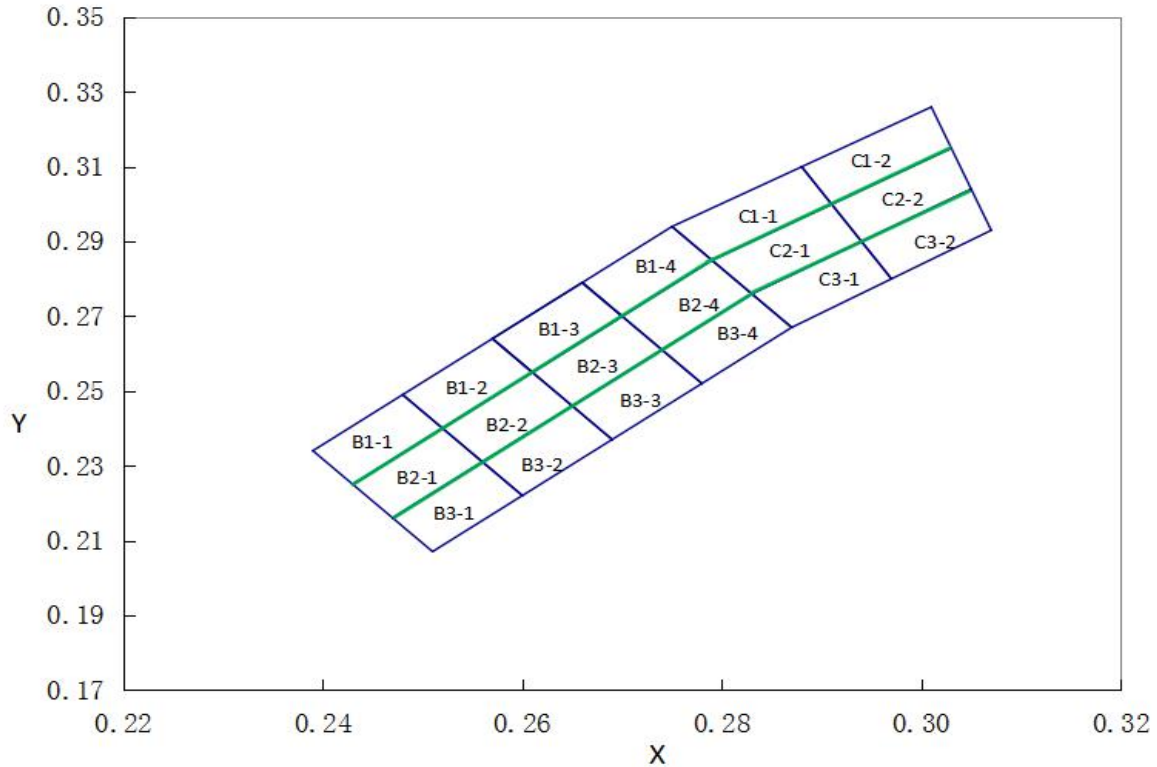

Chromaticity Coordinates Specifications for Bin Rank

(IF=5mA, Ta=25°C)

Bin Code		Bottom	Left	Top	Right
B1-1	X	0.2430	0.2390	0.2480	0.2520
	Y	0.2250	0.2340	0.2490	0.2400
B1-2	X	0.2520	0.2480	0.2570	0.2610
	Y	0.2400	0.2490	0.2640	0.2550
B1-3	X	0.2610	0.2570	0.2660	0.2700
	Y	0.2550	0.2640	0.2790	0.2700
B1-4	X	0.2700	0.2660	0.2750	0.2790
	Y	0.2700	0.2790	0.2940	0.2850
B2-1	X	0.2470	0.2430	0.2520	0.2560
	Y	0.2160	0.2250	0.2400	0.2310
B2-2	X	0.2560	0.2520	0.2610	0.2650
	Y	0.2310	0.2400	0.2550	0.2460
B2-3	X	0.2650	0.2610	0.2700	0.2740

S192W-W2-1AG

1.6x0.8mm, White LED

Surface Mount Chip LED Indicator

Technical Data Sheet

	Y	0.2460	0.2550	0.2700	0.2610
B2-4	X	0.2740	0.2700	0.2790	0.2830
	Y	0.2610	0.2700	0.2850	0.2760
B3-1	X	0.2510	0.2470	0.2560	0.2600
	Y	0.2070	0.2160	0.2310	0.2220
B3-2	X	0.2600	0.2560	0.2650	0.2690
	Y	0.2220	0.2310	0.2460	0.2370
B3-3	X	0.2690	0.2650	0.2740	0.2780
	Y	0.2370	0.2460	0.2610	0.2520
B3-4	X	0.2780	0.2740	0.2830	0.2870
	Y	0.2520	0.2610	0.2760	0.2670
C1-1	X	0.2790	0.2750	0.2880	0.2910
	Y	0.2850	0.2940	0.3100	0.3000
C1-2	X	0.2910	0.2880	0.3010	0.3030
	Y	0.3000	0.3100	0.3260	0.3150
C2-1	X	0.2830	0.2790	0.2910	0.2940
	Y	0.2760	0.2850	0.3000	0.2900
C2-2	X	0.2940	0.2910	0.3030	0.3050
	Y	0.2900	0.3000	0.3150	0.3040
C3-1	X	0.2870	0.2830	0.2940	0.2970
	Y	0.2670	0.2760	0.2900	0.2800
C3-2	X	0.2970	0.2940	0.3050	0.3070
	Y	0.2800	0.2900	0.3040	0.2930

Notes:

1. Color coordinates measurement allowance is ± 0.01 .
2. One delivery will include up to two consecutive color ranks and three luminous intensity ranks of the products the quantity-ratio of the ranks is decided by Luckylight.

Spec No.: S192

Issue No.: G-Rev-4

Luckylight Electronics Co., Ltd

Copyright © 2023 Luckylight All Rights Reserved

Date: 22-Mar-2023

E-mail: sales@luckylight.cn

[http:// www.luckylight.cn](http://www.luckylight.cn)

Page: 6 / 12

S192W-W2-1AG

1.6x0.8mm, White LED
Surface Mount Chip LED Indicator

Technical Data Sheet

Reel Dimensions:

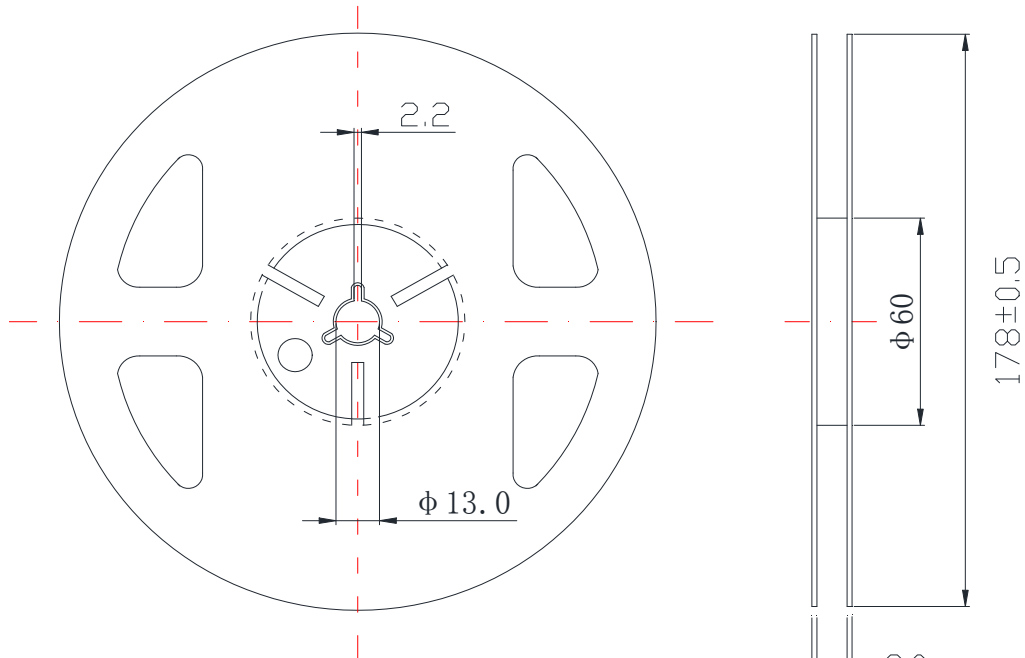

Carrier Tape Dimensions:

Loaded quantity 4000 pcs per reel.

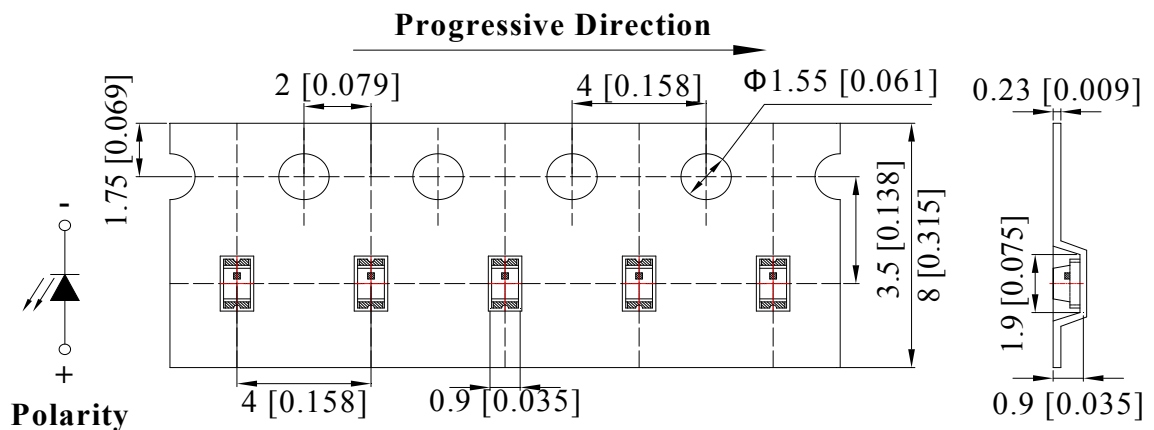

Unit: mm
Tolerance: $\pm 0.10\text{mm}$

S192W-W2-1AG

1.6x0.8mm, White LED
Surface Mount Chip LED Indicator



Technical Data Sheet

Packing & Label Specifications:

Moisture Resistant Packaging:

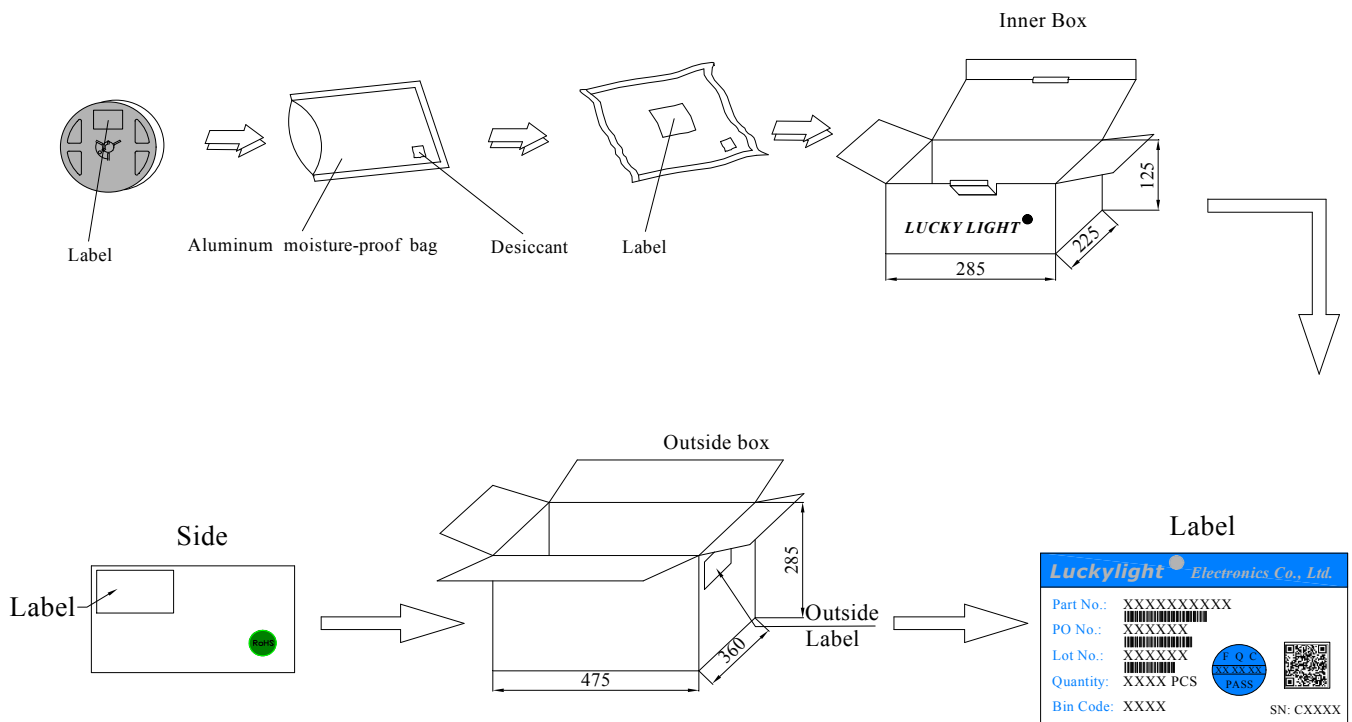

a. 10 reel/Inner Box.

b. 6 Inner Boxes/Outside Box.

Spec No.: S192

Issue No.: G-Rev-4

LuckyLight Electronics Co., Ltd

Copyright © 2023 LuckyLight All Rights Reserved

Date: 22-Mar-2023

E-mail: sales@luckylight.cn

http:// www.luckylight.cn

Page: 8 / 12

S192W-W2-1AG

1.6x0.8mm, White LED

Surface Mount Chip LED Indicator

Technical Data Sheet

CAUTIONS

1. Handling Precautions:

- 1.1. Handle the component along the side surfaces by using forceps or appropriate tools.
- 1.2. Do not directly touch or handle the silicone lens surface. It may damage the internal circuitry.
- 1.3. Do not stack together assembled PCBs containing exposed LEDs. Impact may scratch the silicone lens or damage the internal circuitry.

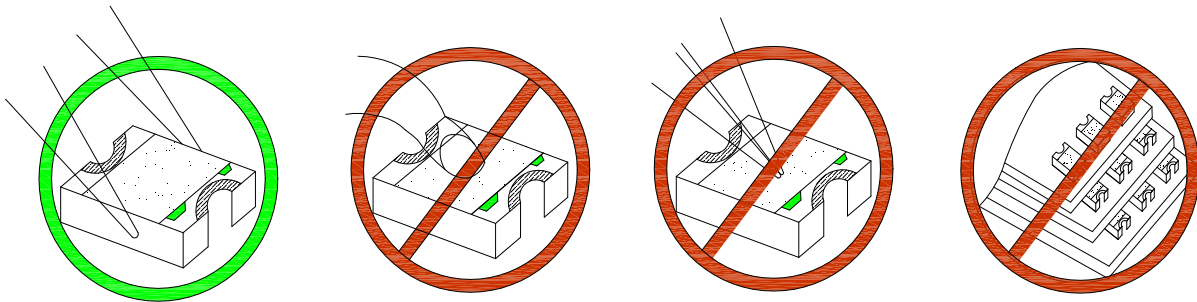

Compare to epoxy encapsulant that is hard and brittle, silicone is softer and flexible. Although its characteristic significantly reduces thermal stress, it is more susceptible to damage by external mechanical force. As a result, special handling precautions need to be observed during assembly using silicone encapsulated LED products. Failure to comply might lead to damage and premature failure of the LED.

2. Storage

- 2.1. Do not open moisture proof bag before the products are ready to use.
- 2.2. Before opening the package, the LEDs should be kept at 30°C or less and 60%RH or less.
- 2.3. The LEDs should be used within a year.
- 2.4. After opening the package, the LEDs should be kept at 30°C or less and 60%RH or less.
- 2.5. The LEDs should be used within 168 hours after opening the package.
- 2.6. If the moisture adsorbent material has fabled away or the LEDs have exceeded the storage time, baking treatment should be performed using the following conditions. Baking treatment: 65±5°C for 24 hours.

S192W-W2-1AG

1.6x0.8mm, White LED
Surface Mount Chip LED Indicator



Technical Data Sheet

3. Soldering Condition

3.1. Pb-free solder temperature profile

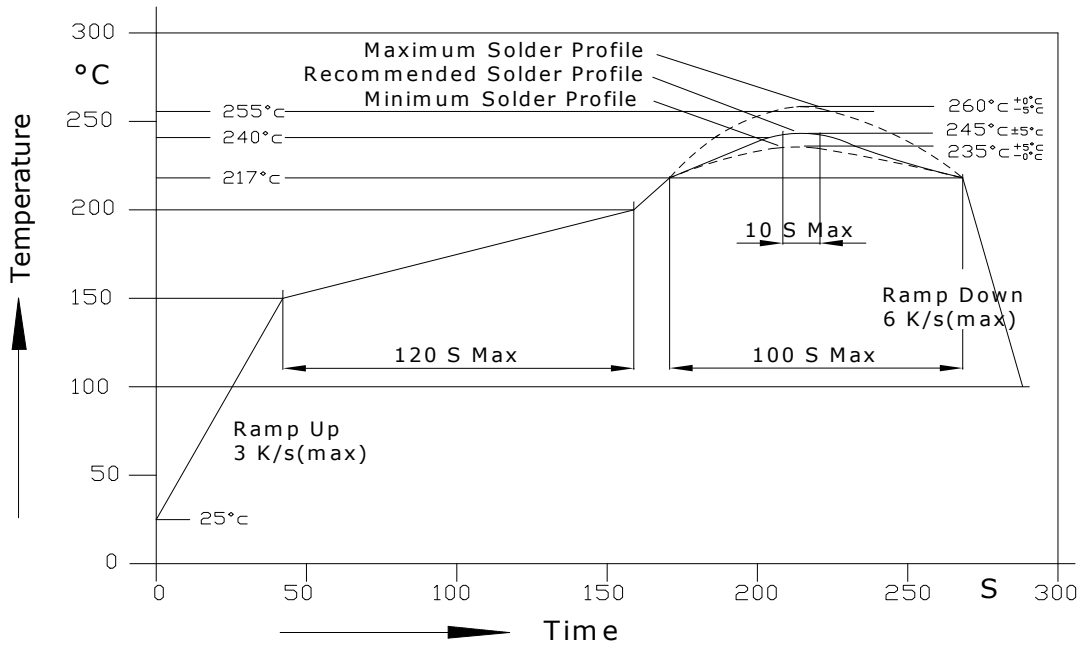

3.2. Reflow soldering should not be done more than two times.

3.3. When soldering, do not put stress on the LEDs during heating.

3.4. After soldering, do not warp the circuit board.

3.5. Recommended soldering conditions:

Reflow soldering		Soldering iron	
Pre-heat	150~200°C	Temperature	300°C Max.
Pre-heat time	120 sec. Max.	Soldering time	3 sec. Max.
Peak temperature	260°C Max.		(one time only)
Soldering time	10 sec. Max.(Max. two times)		

3.6. Because different board designs use different number and types of devices, solder pastes, reflow ovens, and circuit boards, no single temperature profile works for all possible combinations.

S192W-W2-1AG

1.6x0.8mm, White LED

Surface Mount Chip LED Indicator

Technical Data Sheet

However, you can successfully mount your packages to the PCB by following the proper guidelines and PCB-specific characterization.

4. Drive Method

4.1. An LED is a current-operated device. In order to ensure intensity uniformity on multiple LEDs connected in parallel in an application, it is recommended that a current limiting resistor be incorporated in the drive circuit, in series with each LED as shown in Circuit A below.

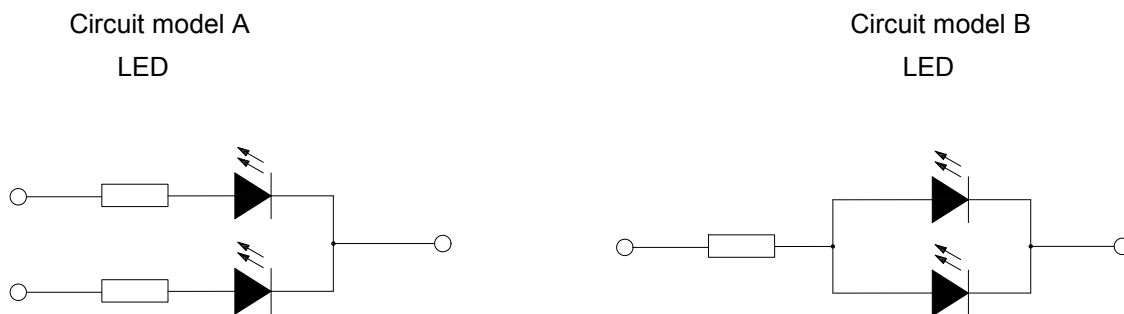

a. Recommended circuit.

b. The brightness of each LED might appear different due to the differences in the I-V characteristics of those LEDs.

5. ESD (Electrostatic Discharge):

Static Electricity or power surge will damage the LED. Suggestions to prevent ESD damage:

- Use of a conductive wrist band or anti-electrostatic glove when handling these LEDs.
- All devices, equipment, and machinery must be properly grounded.
- Work tables, storage racks, etc. should be properly grounded.
- Use ion blower to neutralize the static charge which might have built up on surface of the LED's plastic lens as a result of friction between LEDs during storage and handling.

ESD-damaged LEDs will exhibit abnormal characteristics such as high reverse leakage current, low forward voltage, or “no lightup” at low currents. To verify for ESD damage, check for “lightup” and V_f of the suspect LEDs at low currents. The V_f of “good” LEDs should be $>2.0V@0.1mA$ for InGaN product and $>1.4V@0.1mA$ for AlInGaP product.

S192W-W2-1AG

1.6x0.8mm, White LED

Surface Mount Chip LED Indicator



Technical Data Sheet

Terms and conditions for the usage of this document

1. The information included in this document reflects representative usage scenarios and is intended for technical reference only.
2. The part number, type, and specifications mentioned in this document are subject to future change and improvement without notice. Before production usage customer should refer to the latest datasheet for the updated specifications.
3. When using the products referenced in this document, please make sure the product is being operated within the environmental and electrical limits specified in the datasheet. If customer usage exceeds the specified limits, Luckylight will not be responsible for any subsequent issues.
4. The information in this document applies to typical usage in consumer electronics applications. If customer's application has special reliability requirements or have life-threatening liabilities, such as automotive or medical usage, please consult with Luckylight representative for further assistance.
5. The contents and information of this document may not be reproduced or re-transmitted without permission by Luckylight.